



Tile & Stone Installation Systems

Product Selection Catalog



Includes

Concrete &
Substrate Preparation



Tile, Stone & Surface Care



Now Offering
Profiles & Trims!

TABLE OF CONTENTS

by Category

About LATICRETE

About Us.....	8-9
Brand Promises.....	10
Warranties.....	11
Global Reach.....	12-13
Support, Training & Education.....	14-15
Sustainability & Safety.....	16-17
Community & Social Media.....	18
Quality & Innovation.....	19
Product Line Overview.....	20-21

PRODUCT UPDATES

New Product Introductions.....	22-23
Profiles & Trims.....	24
ANYCOLOR™ Custom Color Program.....	25

Concrete & Substrate Preparation

BONDING PRIMERS & MOISTURE BARRIERS

VAPOR BAN™ E.....	27
VAPOR BAN ER.....	28
VAPOR BAN Primer ER.....	28
NEW Primer Plus.....	29
PRIME-N-BOND™.....	29

Moisture Barriers & Primers Selection Guide	30
--	----

SELF-LEVELING UNDERLAYMENTS

NEW NXT® Level Plus Lite.....	31
NXT Level Plus.....	31
NXT Level.....	32
NXT Level Flow.....	32

SELF-LEVELING OVERLAYMENTS

NXT Level SP.....	33
NXT Level DL.....	33

SKIM COAT, PATCH & REPAIR

NXT® Patch.....	34
Skim Lite.....	34

Patch, Repair & Self-Leveling Underlayments Selection Guide	36
--	----

Self-Leveling Overlayments Selection Guide	37
---	----

THICK BED MORTARS, SCREEDS & ADDITIVES

3701 Lite Mortar.....	38
3701 Lite Mortar R.....	38
Quick Cure Mortar Bed.....	39
3701 Fortified Mortar.....	39
3701 Mortar Admix.....	40
226 Thick Bed Mortar.....	40
209 Floor Mud.....	40

Thick Bed Mortars & Screeds Selection Guide	41
--	----

TOOLS

Pro-Mix Station.....	42
Pro-Kart.....	42
Underlayment Tool Kit.....	42
NIVCOMP Digital Level.....	43
Elevation Pins.....	43

Plaza & Deck System

Tile Drain Mat.....	45
3701 Lite Mortar.....	38
3701 Lite Mortar R.....	38
3701 Fortified Mortar.....	39
226 Thick Bed Mortar.....	40
HYDRO BAN® Waterproofing Membrane.....	57
9235 Waterproofing Membrane.....	58
254 PLATINUM™ Plus.....	76
254 PLATINUM.....	76
PERMACOLOR® Select Base.....	95
PERMACOLOR Grout.....	97

Waterproofing & Shower Systems

SHEET MEMBRANE & ACCESSORIES

HYDRO BAN Sheet Membrane.....	47
HYDRO BAN Sealing Tape.....	47
HYDRO BAN Preformed Corners.....	48
HYDRO BAN Collars and Mixing Valve Seal.....	48
HYDRO BAN Drain Collars.....	49
HYDRO BAN Accessories.....	49

PREFORMED SHOWER SYSTEM

HYDRO BAN Shower Pans and Kits.....	50
HYDRO BAN Pre-Sloped Shower Pan.....	51
HYDRO BAN Linear Pre-Sloped Shower Pan.....	51
HYDRO BAN Preformed Bench.....	52
HYDRO BAN Preformed Seats.....	52
HYDRO BAN Preformed Niches.....	53
HYDRO BAN Board.....	53

DRAINS

HYDRO BAN Linear Drains and Trough.....	54
HYDRO BAN Bonding Flange Drains.....	55
HYDRO BAN Point Drains.....	55

LIQUID APPLIED WATERPROOFING

HYDRO BAN XP.....	56
HYDRO BAN Waterproofing Membrane.....	57
HYDRO BAN Quick Cure.....	57
9235 Waterproofing Membrane.....	58
HYDRO BARRIER™ Plus.....	58

CEMENTITIOUS WATERPROOFING

HYDRO BAN Cementitious Waterproofing Membrane.....	59
--	----

FLASHING & SPECIALTY WATERPROOFING

LATAPOXY® Waterproofing Flashing Mortar.....	60
--	----

TOOL, ACCESSORIES & SEALANTS

HYDRO BAN Board Accessories.....	60
LATICRETE® Flashing Sealant.....	61
HYDRO BAN Adhesive & Sealant.....	61

Uncoupling & Anti-Fracture Membranes

UNCOUPLING MAT

STRATA_MAT™.....	63
STRATA_MAT XT.....	63

SOUND & CRACK ISOLATION

FRACTURE BAN®.....	64
FRACTURE BAN SC.....	64
125 TRI MAX®.....	65
170.3 Sound & Crack Isolation Mat.....	66
170.5 Sound & Crack Isolation Mat.....	66

LIQUID APPLIED ANTI-FRACTURE MEMBRANES

HYDRO BAN XP.....	56
HYDRO BAN Waterproofing Membrane.....	57
9235 Waterproofing Membrane.....	58
Blue 92 Anti-Fracture Membrane and Crack Suppression Kit.....	66

Waterproofing & Sound Control Selection Guide	67
--	----

Radiant Floor Heating

MATS & HEATING WIRING

STRATA_HEAT™ MAT	69
STRATA_HEAT Spliceless Wire	69

THERMOSTATS

STRATA_HEAT Thermostats	70
-------------------------------	----

COMPLEMENTARY PRODUCTS

STRATA_HEAT Thermal Pack	71
--------------------------------	----

Tile & Stone Adhesives & Mortars

EPOXY ADHESIVES

LATAPOXY® 310 Stone Adhesive	73
LATAPOXY 310 Cordless Mixer	73
LATAPOXY 300 Adhesive	74
LATAPOXY BIOGREEN™ 300 Adhesive	74

NON-MODIFIED ADHESIVE MORTARS

272 Mortar	75
317 Mortar	75

POLYMER MODIFIED THIN-SET ADHESIVE MORTARS

NEW 254 PLATINUM™ Plus	76
254 PLATINUM	76
254R PLATINUM Rapid	77
Glass Tile Adhesive Lite	77
253 GOLD™	78
253R GOLD Rapid	78
252 SILVER™	79

LARGE & HEAVY TILE MORTARS

MULTIMAX™ Lite	79
TRI-LITE™ Rapid	80
TRI-LITE™	80
4-XLT	81
4-XLT Rapid	81
LHT™ Plus	82
LHT	82

MORTAR & ADHESIVE ADDITIVES

333 Super Flexible Additive	83
3701 Mortar Admix	40
STRATA_HEAT Thermal Pack	71

PRE-MIXED MASTIC

15 Premium Mastic Adhesive	84
----------------------------------	----

Adhesive & Mortar Selection Guide	86-87
--	-------

Tile & Stone Grouts

EPOXY GROUTS

SPECTRALOCK® PRO Premium Translucent Grout	90
SPECTRALOCK PRO Premium Grout	90
SPECTRALOCK DAZZLE™	91
SPECTRALOCK Grout Part C Color Additive	91
SPECTRALOCK 2000 IG	92

PRE-MIXED TILE GROUT

SPECTRALOCK 1	93
READY-TO-USE™ Grout	93

CEMENTITIOUS GROUT

PERMACOLOR® Select Base	95
PERMACOLOR Select Color Kit	95
PERMACOLOR Select NS Base	96
PERMACOLOR Grout	96
1500 Sanded Grout	97
1600 Unsanded Grout	97

Color & Coverage Charts

Color Chart	98
Coverage Chart	99-101

Grout Selection Guide	102-103
------------------------------------	---------

Caulks & Sealants

ACRYLIC SEALANTS

Premium Acrylic Caulk	104
-----------------------------	-----

SILICONE SEALANTS

LATASIL™	105
LATASIL 9118 Primer	105

Tile, Stone & Surface Care

CLEAN | DAILY CLEANERS

STONETECH Revitalizer® Cleaner & Protector	108
STONETECH Stone & Tile Cleaner	108
STONETECH Quartz & Tile Cleaner	109
STONETECH Stainless Steel Pro Cleaner	109

CLEAN | HEAVY DUTY CLEANERS

STONETECH KlenzAll™ Cleaner	110
STONETECH DeepKlenz™ Cleaner	110
STONETECH Restore™ Acidic Cleaner	111
STONETECH Epoxy Grout Haze & Coating Stripper	111
STONETECH Oil Stain Remover	112
STONETECH Mold & Mildew Stain Remover	113
STONETECH Soap Scum Remover	113

PROTECT | SEALERS

STONETECH® BulletProof® Sealer	114
STONETECH Heavy Duty Sealer	114
STONETECH Stone, Tile & Grout Sealer	115
STONETECH Impregnator Pro® Sealer	116
STONETECH Quartz & Porcelain Tile Sealer	116
STONETECH Countertop Warranty Care Kit	117

PROTECT | EXTERIOR SEALERS

STONETECH Salt Water-Resistant Sealer	118
STONETECH Heavy Duty Exterior Sealer	118

PROTECT | GROUT

STONETECH Heavy Duty Grout Sealer	120
STONETECH Grout Release	121
STONETECH GroutUp™ Additive	121

ENHANCE | ENHANCING SEALERS & POLISH

STONETECH Enhancer Pro™ Sealer	122
STONETECH Enhancer & Sealer	122
STONETECH High Gloss Finish & Sealer	123
STONETECH Semi Gloss Finish & Sealer	123
STONETECH Stone Polish	124

RESTORE | RESTORATION

STONETECH Honing Powder	125
STONETECH Polishing Powder	125

STONETECH Selection Guide	126-127
--	---------

Product Selection Guides

Patch, Repair & Self-Leveling Underlayments Selection Guide	36
Self-Leveling Overlayments Selection Guide	37
Thick Bed Mortars & Screeds Selection Guide	41
Waterproofing & Sound Control Selection Guide	67
Adhesive & Mortar Selection Guide	86-87
Grout Selection Guide	102-103
STONETECH Selection Guide	126-127

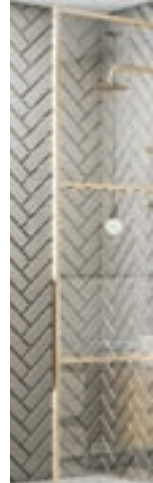

TABLE OF CONTENTS

Alphabetical by Product

125 TRI MAX®	65	LATAPOXY® 300 Adhesive	74
15 Premium Mastic Adhesive	84	LATAPOXY 310 Cordless Mixer	73
1500 Sanded	97	LATAPOXY 310 Stone Adhesive	73
1600 Unsanded Grout	97	LATAPOXY BIOGREEN™ 300 Adhesive	74
170.3 Sound & Crack Isolation Mat	66	LATAPOXY Waterproofing Flashing Mortar	60
170.5 Sound & Crack Isolation Mat	66	LATASIL™	105
209 Floor Mud	40	LATASIL 9118 Primer	105
226 Thick Bed Mortar	40	LATICRETE® Flashing Sealant	61
252 SILVER™	79	LHT	82
253 GOLD™	78	LHT™ Plus	82
253R GOLD Rapid	78	MULTIMAX™ Lite	79
254 PLATINUM™	76	NIVCOMP Digital Level	43
NEW 254 PLATINUM Plus	76	NXT® Level	32
254R PLATINUM Rapid	77	NXT Level DL	33
272 Mortar	75	NXT Level Flow	32
317 Mortar	75	NXT Level Plus	31
333 Super Flexible Additive	83	NXT Level SP	33
3701 Fortified Mortar	39	NEW NXT Level Plus Lite	31
3701 Lite Mortar	38	NXT Patch	34
3701 Lite Mortar R	38	PERMACOLOR® Grout	96
3701 Mortar Admix	40	PERMACOLOR Select Base	95
4-XLT	81	PERMACOLOR Select Color Kit	95
4-XLT Rapid	81	PERMACOLOR Select NS Grout Base	96
9235 Waterproofing Membrane	58	Premium Acrylic Caulk	104
Blue 92 Anti-Fracture Membrane and Crack Suppression Kit	66	PRIME-N-BOND™	29
Elevation Pins	43	NEW Primer Plus	25
FRACTURE BAN®	64	Pro-Kart	29
FRACTURE BAN SC	64	Pro-Mix Station	42
Glass Tile Adhesive Lite	77	Quick Cure Mortar Bed	39
HYDRO BAN® Accessories	49	READY-TO-USE™ Grout	93
HYDRO BAN Adhesive & Sealant	61	Skim Lite	34
HYDRO BAN Board	53	SPECTRALOCK® 1	93
HYDRO BAN Board Accessories	60	SPECTRALOCK 2000 IG	92
HYDRO BAN Bonding Flange Drains	55	SPECTRALOCK Dazzle™	91
HYDRO BAN Cementitious Waterproofing Membrane	59	SPECTRALOCK Grout Part C Color Additive	92
HYDRO BAN Collars and Mixing Valve Seal	48	SPECTRALOCK Pro Premium Grout	90
HYDRO BAN Drain Collars	49	SPECTRALOCK Pro Premium Translucent Grout	90
HYDRO BAN Linear Drains and Trough	54	STONETECH BulletProof® Sealer	114
HYDRO BAN Linear Point Drains	55	STONETECH® Countertop Warranty Care Kit	117
HYDRO BAN Linear Pre-Sloped Shower Pan	51	STONETECH DeepKlenz™ Cleaner	110
HYDRO BAN Waterproofing Membrane	57	STONETECH Enhancer & Sealer	122
HYDRO BAN Pre-Sloped Shower Pan	51	STONETECH Enhancer Pro™ Sealer	122
HYDRO BAN Preformed Bench	52	STONETECH Epoxy Grout Haze & Coating Stripper	111
HYDRO BAN Preformed Corners	48	STONETECH Grout Release	121
HYDRO BAN Preformed Niches	53	STONETECH GroutUp™ Additive	121
HYDRO BAN Preformed Seats	52	STONETECH Heavy Duty Exterior Sealer	118
HYDRO BAN Quick Cure	57	STONETECH Heavy Duty Grout Sealer	120
HYDRO BAN Sealing Tape	47	STONETECH Heavy Duty Sealer	114
HYDRO BAN Shower Pans and Kits	50	STONETECH High Gloss Finish & Sealer	123
HYDRO BAN Sheet Membrane	47	STONETECH Honing Powder	125
HYDRO BAN XP	56	STONETECH Impregnator Pro® Sealer	116
HYDRO BARRIER™ Plus	58	STONETECH KlenzAll™ Cleaner	110

STONETECH Mold & Mildew Stain Remover	113
STONETECH® Oil Stain Remover.....	112
STONETECH Polishing Powder.....	125
STONETECH Quartz & Porcelain Tile Sealer	116
STONETECH Quartz & Tile Cleaner	109
STONETECH Restore™ Acidic Cleaner	111
STONETECH Revitalizer® Cleaner & Protector	108
STONETECH Salt Water-Resistant Sealer	118
STONETECH Semi Gloss Finish & Sealer	123
STONETECH Soap Scum Remover	113
STONETECH Stainless Steel Pro Cleaner	109
STONETECH Stone & Tile Cleaner	108
STONETECH Stone Polish.....	124
STONETECH Stone, Tile & Grout Sealer.....	115
STRATA_HEAT™ Mat.....	69
STRATA_HEAT Spliceless Wire.....	69
STRATA_HEAT Thermal Pack	71
STRATA_HEAT Thermostats	70
STRATA_MAT™	63
STRATA_MAT XT	63
Tile Drain Mat.....	45
TRI-LITE™	80
TRI-LITE Rapid.....	80
Underlayment Tool Kit.....	42
VAPOR BAN™ E	27
VAPOR BAN ER.....	28
VAPOR BAN Primer ER.....	28

Product Selection Guides

Patch, Repair & Self-Leveling Underlayments Selection Guide	36
Self-Leveling Overlayments Selection Guide.....	37
Thick Bed Mortars & Screeds Selection Guide.....	41
Waterproofing & Sound Control Selection Guide.....	67
Adhesive & Mortar Selection Guide	86-87
Grout Selection Guide	102-103
STONETECH Selection Guide	126-127



Circa

No matter your project...



Allison Eden Studios
New York City, New York, USA
254 PLATINUM™

LATICRETE has you covered.



TWA Hotel
Queens, New York, USA
SUPERCAP® System



'50s

4237, first latex thin-set mortar additive in the industry



'60s

LATAPOXY® 210, first cement-based epoxy resin



'70s

9235, first thin, liquid, cold-applied, load-bearing waterproof membrane



'90s

LATAPOXY 2000, first industrial strength 100% epoxy resin grout
First educational program for architects **approved by AIA**

FOR THE BUILDERS OF A BETTER WORLD™

For over 65 years, we at LATICRETE have built our reputation tile by tile. We strive to earn your trust with high quality and high-performing installation systems and building finishing solutions.

If you are new to LATICRETE, welcome. If you have never come across our products before, your success is our main goal, and we are here to help you. If you are a returning customer, thank you; we value your continued support and appreciate your business.

With almost seven decades of setting industry standards, LATICRETE is the name architects, designers and professional installers know and rely on. No matter who you are, we are here to support and serve you.

Happy Installing!
The LATICRETE Team



New Millenium

SPECTRALOCK® Grout, first epoxy grout with patented technology offering stain and chemical resistance

HYDRO BAN®, first no fabric required, liquid applied waterproof membrane
125 Sound & Crack Adhesive, first one step tile adhesive providing both sound control and anti-fracture performance



'10s & '20s

Masonry Veneer Installation System (MVIS™), industry first comprehensive system for installation of manufactured stone veneers

SPECTRALOCK® 1, first pre-mixed grout with epoxy performance

OUR PROMISE TO YOU



The LATICRETE **Brand Promises** are a company-wide global initiative that builds upon our legacy of research and development of innovative installation products, systems and solutions.



They serve as a call-to-action and highlight six strategic areas of focus:



- Developing innovative solutions,
- Committing to sustainability,
- Enabling iconic design,
- Fostering trust for life,
- Providing the best installer experience, and
- Serving customers as family.



These promises are the cornerstone of our company mission.



UNMATCHED PEACE OF MIND

LATICRETE offers you the **best system warranties** in the industry. By using the combinations of products shown below, specify a complete single-source system and rest easy. When you install one of our systems, the job is built to last.

LIFETIME SYSTEM WARRANTY

See Data Sheet 230.99 for complete warranty information.

LIFETIME WARRANTY[†]

APPLICATION	PRODUCTS
Underlayment	NXT LEVEL PLUS LITE NXT [®] LEVEL PLUS Skim Lite NXT Patch
Primer	Primer Plus PRIME-N-BOND [™]
Floor Warming^Δ	STRATA_HEAT [™] Wire STRATA_HEAT STRATA_HEAT Thermal Packs [†] 4-XLT with STRATA_HEAT Thermal Packs
Vapor Reduction	VAPOR BAN [™] E VAPOR BAN ER VAPOR BAN Primer ER
Waterproofing/ Anti-Fracture	HYDRO BAN [®] HYDRO BAN XP 9235 Waterproofing Membrane
Waterproofing	HYDRO BAN Sheet Membrane HYDRO BAN Quick Cure
Shower System	HYDRO BAN Pre-Sloped Shower Pan (and applicable accessories) HYDRO BAN Linear Pre-Sloped Shower Pan (and applicable accessories) HYDRO BAN Shower and HYDRO BAN Shower Kits (and applicable accessories) HYDRO BAN Linear Drain (and applicable accessories) HYDRO BAN Bonding Flange Drain (and applicable accessories) HYDRO BAN Board (and applicable accessories) 4-XLT ^Δ
Uncoupling	STRATA_MAT [™] STRAT_MAT XT
Thick Bed Mortar	3701 Fortified Mortar Bed 3701 Lite Mortar or 3701 Lite Mortar R Quick Cure Mortar Bed
Slurry Bond Coat	254 PLATINUM [™] 254 PLATINUM PLUS
Thin Bed Method	254 PLATINUM (regular or rapid version) 254 PLATINUM PLUS LATAPOXY [®] 300 Adhesive or BIOGREEN [™] 300
Large, Heavy Tile Method	MULTIMAX [™] LITE
Grout	SPECTRALOCK [®] PRO Premium Grout SPECTRALOCK 1 Pre-Mixed Grout PERMACOLOR [®] Select
Profiles & Trims	Stainless Steel Aluminum ^{**}
Sealant[†]	LATASIL [™] LATASIL 9118 Primer

[†] Use of suitable flexible sealant is required per Tile Council of North America Detail EJ171 for use in expansion joints, coves, corners, changes in plane and other joints or wherever tile or stone abuts dissimilar materials or restraining surfaces.

^{**} Residential projects only.

^Δ 4-XLT for use to install HYDRO BAN[®] Pre-Sloped Shower Pans to substrate only.

^Δ Floor Warming Thermostat and STRATA_HEAT[™] Thermostat sold by LATICRETE warrants parts and materials for one (1) year from the date of purchase. The sole remedy for the Floor Warming Thermostats and STRATA_HEAT Thermostats is product replacement (see Data Sheet 230.13 for full details on the LATICRETE[®] Product Limited Warranty).
[†]4-XLT with STRATA_MAT Thermal Packs when used as a large & heavy tile adhesive mortar.

Consult our website at www.laticrete.com for the most current versions of product data sheets, warranties, and SDS. Content of this brochure is for informational purposes only. Refer to individual product data sheets and warranties for complete information.

Refer to individual product data sheets and warranties for complete information.

^ΔUnited States Patent No.: 6,784,229 B2 (and other Patents). [†]United States Patent No.: 6,881,768 (and other Patents).

25 YEAR SYSTEM WARRANTY

See Data Sheet 025.0 for complete warranty information.

25 YEAR WARRANTY^Δ

APPLICATION	PRODUCTS
Air Barrier Components (exterior veneers only)	MVIS [™] Air & Water Barrier LATAPOXY [®] Waterproof Flashing Mortar LATICRETE Flashing Sealant
Underlayment	NXT [®] LEVEL PLUS LITE NXT LEVEL PLUS SUPERCAP [®] SC500 Plus Skim Lite NXT Patch
Primer	Primer Plus PRIME-N-BOND [™]
Floor Warming^Δ	STRATA_HEAT [™] Wire STRATA_HEAT STRATA_HEAT Thermal Packs [†] 4-XLT with STRATA_HEAT Thermal Packs
Vapor Reduction	VAPOR BAN [™] E VAPOR BAN ER VAPOR BAN Primer ER
Waterproofing/Anti-Fracture	HYDRO BAN [®] HYDRO BAN XP 9235 Waterproofing Membrane
Waterproofing	HYDRO BAN Sheet Membrane LATAPOXY Waterproof Flashing Mortar HYDRO BAN Cementitious Waterproofing Membrane HYDRO BAN Quick Cure
Shower System	HYDRO BAN Pre-Sloped Shower Pan (and applicable accessories) HYDRO BAN Linear Pre-Sloped Shower Pan (and applicable accessories) HYDRO BAN Shower and HYDRO BAN Shower Kits (and applicable accessories) HYDRO BAN Linear Drain (and applicable accessories) HYDRO BAN Bonding Flange Drain (and applicable accessories) HYDRO BAN Board (and applicable accessories) 4-XLT ^Δ
Sound Control/Anti-Fracture	125 TRI MAX [®] 170.3 or 170.5 Sound & Crack Isolation Mat FRACTURE BAN [™] 40 or 90
Plaza & Deck	Plaza and Deck System
Uncoupling	STRATA_MAT [™] STRATA_MAT XT
Thick Bed Method	3701 Fortified Mortar Bed 3701 Lite Mortar or 3701 Lite Mortar R Quick Cure Mortar Bed
Slurry Bond Coat	254 PLATINUM [™] PLUS 254 PLATINUM
Thin Bed/Adhesive Method	254 PLATINUM PLUS 254 PLATINUM (regular or rapid version) LATAPOXY 300 Adhesive or BIOGREEN [™] 300 Glass Tile Adhesive Lite
Large, Heavy Tile Method	MULTIMAX [™] LITE TRI-LITE [™] TRI-LITE RAPID
Spot Bonding	LATAPOXY 310 Stone Adhesive – Standard and Rapid Grade
Grouting/Pointing	SPECTRALOCK [®] PRO Premium Grout (non-industrial applications) SPECTRALOCK 1 Pre-Mixed Grout PERMACOLOR [®] Grout PERMACOLOR Select READY-TO-USE [™] Grout
Profiles & Trims	Stainless Steel Aluminum Brass
Sealant[†]	LATASIL [™] LATASIL 9118 Primer

GLOBALLY PROVEN

What started in a basement in New Haven, CT more than 65 years ago has grown into a reliable, global supply network. LATICRETE® system solutions have been used in the most prestigious and demanding projects around the world. From the bustling streets and subways of New York City to the world's tallest building in Dubai, LATICRETE products are trusted and used throughout the world, whatever the project, whatever the environment.

With business units, distribution and manufacturing facilities on almost every continent (except for Antarctica), our global network can help any project and meet any challenge, with a track record earned over generations.



One World Trade Center | New York, US



St. Louis Gateway Arch | Missouri, US



Seminole Hard Rock
Casino & Hotel |
Florida, US



SoFi Stadium | California, US



Baha Mar | Nassau, Bahamas



The Ned Hotel | London, UK



Ritz Carlton | Budapest, Hungary



Statue of Unity | Gujarat, India



Beijing National Aquatics Centre
| Beijing, China



Marina Bay Sands Infinity
Edge Pool | Singapore



Al Hamra Tower | Kuwait

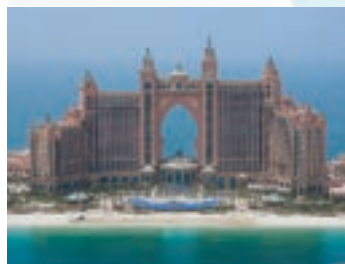

The Palm Atlantis | Dubai UAE

WORLD CLASS TECHNICAL SUPPORT

You're never alone when working with LATICRETE. Our Technical Services team is available to answer any and all questions you may have when it comes to installing our products. Reach out anytime, and one of our in-house experts will get you the answers you're looking for.



Call Us

1-800-243-4788 x1235



Email Us

technicalservices@laticrete.com



Live Chat

laticrete.com – M-F 8a-5p EST



FAQs

Frequently Asked Questions



EDUCATION & TRAINING MADE EASY

Take advantage of FREE training engineered with your needs in mind. Stay up to date with the latest products, industry standards, and help get new employees up to speed fast. We offer a variety of convenient programs, and if there is a topic or product you need more training on, let us know.



LATICRETE University

Learn industry standards and the latest product information in short, self-guided lessons available 24/7. Check them out at laticreteuniversity.com.



On-Site Demos & Training

Need training for associates or customers? Schedule a demo to help improve the knowledge of your team or boost in-store sales with customers. Reach out to a sales rep to schedule.



PROFIT THROUGH KNOWLEDGE
TRAINING

Profit Through Knowledge

Get hands-on with LATICRETE products and learn step by step installations from our expert installers. Contact our technical services team to discuss potential trainings.



YouTube Videos

Tips and tricks, product announcements, how-tos and more! Be sure to subscribe to the LATICRETE channel to stay up to date on the latest videos.



American Institute of Architects Approved Courses

Earn AIA credits, and learn the latest industry standards, how to avoid installation failures, and get tools designed to streamline the specification process. Full course listing at laticrete.com/aiaces.



APPROVED COURSE

ASID • IDC • IDEC • IIDA

International Design Continuing Education Council

Strengthen your understanding and skills in designing a project, creating boldly unique projects that will stand the test of time.



Scan to learn more
about [Education & Training](#).

SUSTAINABLE SOLUTIONS

Our purpose is to improve the built world and the lives of those who build it. And so, we are committed to improving the sustainability of our industry and the health and safety of our customers and employees.

At LATICRETE, we are deeply invested in the development of products and processes that prioritize the well-being of our planet and partners. This has been core to us since our founder sought and invented a better way to install ceramic tile than traditional methods.

Our commitment to this journey is embedded in every aspect of our business, from the products we develop to the waste reduction and recycling measures in our production processes, and beyond.

We prioritize meeting the industry's most stringent standards. Many of our products offer UL GREENGUARD Certifications along with Environmental Product Declarations (EPD) and Health Product Declarations (HPD). These third-party certifications or declarations ensure you can rest easy knowing the products you install are designed to meet the highest environmental standards on the market today. Lower VOCs and lower silica dust means safety for you and your customers.

Because the choices we make today shape the world of tomorrow.



INVESTED IN YOUR SAFETY

LATICRETE is dedicated to advancing the long-term health and safety within the construction industry. We consider our partners an extension of our family, so it's our responsibility to not only supply quality products that are safer to work with but also to offer education and information about new installation techniques.

ProjectSafety™ is a company initiative aimed at increasing the longevity of installers by reducing wear and tear on their bodies. By outlining the best safety protocols, experienced workers can protect themselves and set up apprentices and novice tradesman with the proper instruction to help protect themselves.

LATICRETE has taken strides to make our products safer and easier to work with. **Lightweight products** reduce strain on backs and joints. **Less silica** creates a safer breathing environment. And **simpler system solutions** mean easier installs and less time on the job.



Scan to learn more about [Project Safety](#).

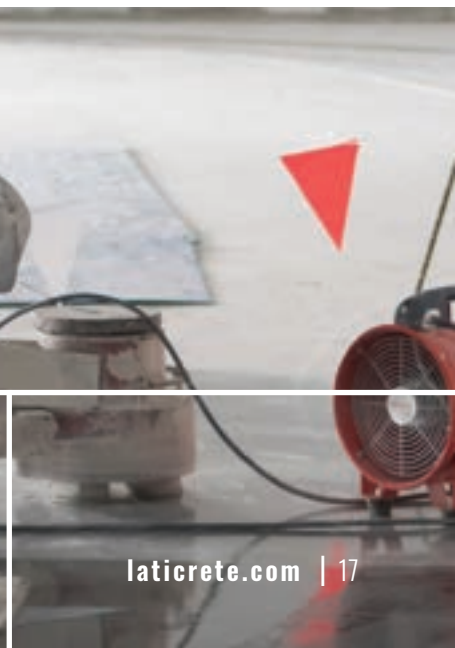
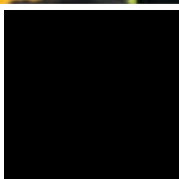

PART OF YOUR COMMUNITY

We're working with the same partners and associations you know and trust every day, supporting the growth, strength and knowledge of our industry for generations to come.

In addition, LATICRETE is committed to helping the communities our facilities and employees are in, working with local partners and charitable organizations to give back to the neighborhoods our employees call home.

CONTRACTORS

TCAA
NTCA
FCICA

International Union of
Bricklayers and Allied Craftworkers

DISTRIBUTORS

CTDA
NAFCD

INDUSTRY

CTEF
TCNA
WFCA
Marble Institute
MMSA
CMHA
TTMAC
USGBC

DESIGNERS & SPECIFIERS

AIA
CSI
IDCEC

CHARITABLE

Habitat for Humanity
United Way
March of Dimes
National Multiple Sclerosis Society
Make-A-Wish Foundation®
Ronald McDonald House Charities®

WE WANT TO HEAR FROM YOU.

We love hearing from our customers! Reach out with questions, tips, or just to say hi. Follow LATICRETE on these social platforms to stay current with the latest products, tutorials, and more!



QUALITY & INNOVATION

As an ISO 9001-certified company, every step of our process is geared towards delivering the highest quality solutions to you. Ranging from product development to manufacturing, these quality standards help assure a consistent, quality installation.



EN



CE

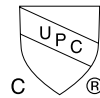

BUILDING SYSTEM SOLUTIONS

Since 1956, LATICRETE has been at the forefront of the industry, leading with pioneering advancements that redefine high-performance tile and stone installation systems and building finishing solutions. We strive to empower architects and construction professionals worldwide with top-notch support and building material solutions.

Tile & Stone Installation Systems

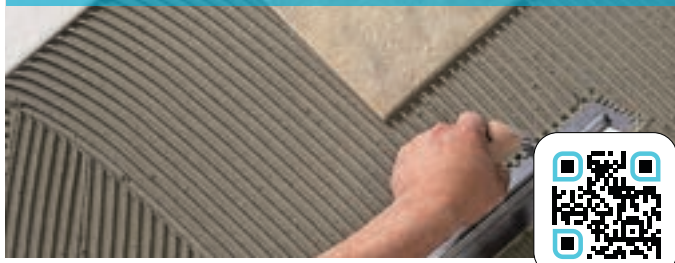

CSI Division 9

Ensure a successful installation each and every time with the most comprehensive assortment of innovative tile and stone installation materials available worldwide. Our industry-leading products offer complete system solutions from the substrate up through the grout for virtually any type of tile or stone installation in commercial, industrial, and residential applications.

Product categories include surface preparation, waterproofing, shower systems, sound control, anti-fracture, floor heating, adhesive mortars, grouts, sealers, cleaners, profiles & trims — all designed to work together, providing a comprehensive installation solution.

Shower Installation Systems



CSI Division 9

The HYDRO BAN® shower system provides everything needed for a worry-free installation. As a single-source supplier for shower installation systems, we offer waterproof membranes, shower pans, benches, niches and drains all with the trusted performance expected from the HYDRO BAN waterproofing line.

Complete your shower by choosing from our adhesives, grouts, sealants and caulks for a beautiful installation that is backed by the industry's best warranty.

Radiant Floor Heating



CSI Division 9

The STRATA_HEAT™ system is the most advanced radiant floor heating system available in the world. Consisting of a high-performance floor heating wire, an uncoupling mat, two Wi-Fi enabled thermostats and the world's first heat conductive thin-set additive — the system provides you with the most advanced and efficient floor heating system for your next installation.

Concrete & Substrate Preparation

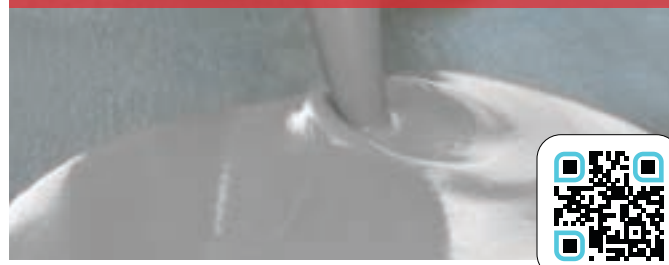

CSI Division 3 & 9

A quality finished floor starts with a properly prepared surface – one that guarantees a long-lasting, durable installation. Our time-tested surface preparation products are formulated to preserve quality by protecting installations from water vapor transmission, sound transmission and cracks. They provide a perfectly level and flat substrate to accommodate a variety of floor finishes including vinyl, wood, carpet and tile.

When combined with the SUPERCAP® System, a high-volume, time-saving delivery system that can pump material up to 50 stories high, you can expect predictable quality results. L&M™ curing and sealing treatments, floor hardeners, densifiers and polished concrete systems further ensure your floors are safe, resilient, and easy to maintain.

Reliable time-tested classics to groundbreaking innovations, our extensive product portfolio offers superior quality and unbeatable support. We are fully committed to a complete system approach, and our offerings align seamlessly with CSI specification sections.



Profiles & Trims

CSI Division 9

Whether looking for a sleek, modern look or a more traditional design, this line offers the flexibility and versatility to achieve any aesthetic in commercial and residential applications. Available in aluminum, stainless steel, brass, and PVC, these profiles and trim pieces are crafted with the utmost precision, to create premium-quality and a consistent appearance from piece to piece.

Our profiles and trims can protect tile edges and enhance safety all while providing a decorative finishing touch to any room. The comprehensive line includes edging in various shapes, coves, stair nosing, skirting, transitions, and expansion joints - and is compatible with various flooring such as tile, carpet, vinyl, wood and more.



Tile, Stone & Surface Care

CSI Division 9

Reliable and high-performing surface care solutions branded STONETECH®, are designed to clean, protect, restore and enhance. Highly effective at preventing oil, water and stain damage, this range offers natural-look sealers that protect porous stone and tile surfaces but do not alter the surface appearance as well as enhancing sealers that can revive the color or finish of a surface all while protecting.

STONETECH cleaners ranging from daily to heavy duty problem-solving solutions will eliminate everyday spills and restore the appearance without harming the intended surface. Preserve the beauty of stone, tile, and grout with STONETECH.



Adhered Façade & Wall Finish Systems

CSI Division 4 & 7

Keep up with the increasing popularity of adhered masonry veneers. Trust your installations to a complete productivity-boosting system designed to deliver superior, long-term performance on masonry projects of all types including residential, commercial, and industrial applications.

Unlike traditional methods and materials, our Masonry Veneer Installation System (MVIS™) is engineered to create permanent, high-strength installations that use a revolutionary waterproofing technology to protect against weather and water intrusion, as well as provide freeze/thaw stability. MVIS is designed for thin-brick, manufactured stone and natural stone veneers for interior and exterior applications.



Resinous Coating & Floor Finish Systems

CSI Division 3 & 9

Offer unparalleled integral colors, textures, and finishes with high-performance coatings, overlayments, and restoration solutions that give owners exceptionally attractive, durable floors. With the SPARTACOTE® system, the decorative finishes allow you to deliver vivid color and gloss with high impact and wear resistance, quick turnaround, and low maintenance.

NEW PRODUCTS

We're proud to show you the latest from LATICRETE.

Take a look at our newest products, developed and designed for you.



PRIMING, PREPARATION & PROTECTION

Primer Plus

Simplify the product selection process, reduce inventory and ensure your surface is properly adhered with one versatile primer. This premium multi-purpose primer replaces NXT® Primer, SUPERCAP® Primer Plus, and FRACTURE BAN® Primer (pp 29).



VAPOR BAN™ E

A single-coat, 100% solids, liquid-applied 2-part epoxy coating specifically designed to control the moisture vapor emission rate from new or existing concrete slabs prior to installing underlayments up to 100% Relative Humidity (RH) (pp 27).



STRATA_MAT™ 54 FT² Roll

The latest addition to the STRATA_MAT uncoupling mat product line is a convenient 54 ft² roll, designed specifically to meet the demands of smaller residential spaces (pp 63).



Air Barrier C3

The newest solution to changing building codes and complex wall systems — Air Barrier C3 gives you a new option for your customers, creating a continuous class 3 air barrier in an easy single coat application.

NEW DRAINS

HYDRO BAN® Bonding Flange and Tile-In Point Drain

Redesigned and streamlined with direct feedback from installers in the field, our next generation of bonding flanges and tile-in drains are intended to work with a greater number of tile types, sizes, and thicknesses (pp 55).

Whether used for a mud installation, or in conjunction with preformed components like those found in the HYDRO BAN® Shower System, these new improvements are aimed at providing the best installer experience. Available in three different finishes plus a tile-in version, the HYDRO BAN Bonding Flange and Tile-In Drains will now also be available in contractor 10 packs for added convenience.

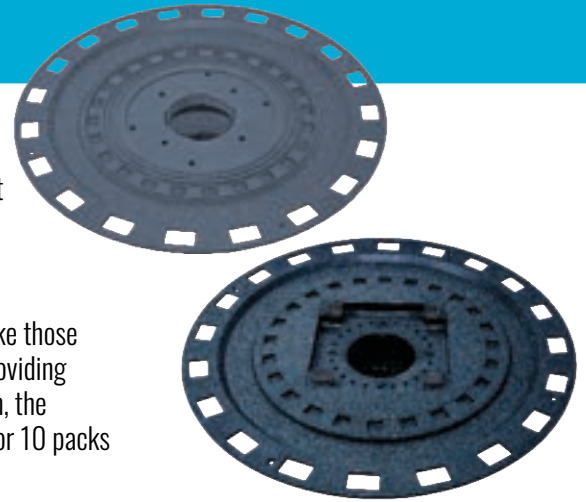

HYDRO BAN Matte Black Drain Grates

Experience the allure of matte black drains for a bold, modern finish. Enhance your shower projects with the durability and style of these beautiful new grates, available for both bonding flange and linear drains (pp 54-55).

This new finish will be promoted with our recently launched Profiles & Trims, which also offers matte black finishes, enabling a completely color-coordinated, warranted system for your next shower installation project.



LIGHTWEIGHT SOLUTIONS

254 PLATINUM™ Plus

The ultimate lightweight thin-set, giving you the highest level of performance while making your job easier. A 25 lb bag provides the same coverage as a 50 lb bag of standard adhesive mortar, while providing you with unsurpassed bond strength (pp 76).

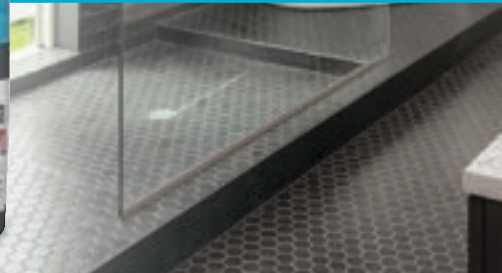

NXT® Level Plus Lite

Lightweight self-leveling underlayment meets heavyweight project challenges. A premium lightweight, fiber-reinforced, cement-based underlayment designed for leveling a variety of interior projects. It's nearly 50% lighter than your standard cured SLU making it a great choice for building projects with load-bearing issues (pp 31).



Take Your Design to the Edge™

Now offering
Profiles & Trims



One Source. Limitless Capabilities.

From profiles and trims to the complete LATICRETE® System. Specify, design, install, or sell a single source installation system from the substrate up — unlock a world of possibilities with LATICRETE!



Visit laticrete.com/profiles or scan for more information.

AnyColor™

Custom Color Matching Program

With the ANYCOLOR™ custom color matching program, there are no limits to your color choices. Create one-of-a-kind looks using a unique color scheme, design, or brand palette – or match an existing design for renovations and additions that flow seamlessly into any project.

GROUTS, CAULKS & SEALANTS, AND PROFILES & TRIMS

Design your tile installations to match colors of the year or any color you can imagine, including thousands of options inspired by top paint brands[^] and color experts. No other manufacturer gives you the ability to match your profiles & trims with custom grout and caulk colors.

CONCRETE OVERLAYS

Looking for unique concrete overlay finishes? We offer a polished concrete solution with a vibrant color, in a monolithic or salt-and pepper look.

HOW IT WORKS

- 1) Pick Your Color.** Choose your desired color from one of the (4) standard color palettes[^]. Note the color name and number.
- 2) Place Your Order*.** Once you've made your selection, contact your local LATICRETE sales representative or customer service team.
- 3) Sit Back and Relax.** Our expert team will begin the color matching process, and within a short period, you'll have your custom color.

Now, the only limit to your design
is your **imagination!**



[Scan for more information.](#)

Color samples are guides only. LATICRETE does not warrant color matching the colors shown here or to any color guide produced. Actual performance and appearance related characteristics as intended for use will depend on job site conditions, lighting, installation techniques and may vary from this catalog, color samples and color swatch on product packaging. Verify actual appearance and compatibility with a mock-up or field test area before installing. No claims for color shade variations will be honored. †Patent pending.

*Match to PANTONE®, BEHR®, Sherwin-Williams®, and Benjamin Moore® color palettes. These brands are not affiliated with the PERMACOLOR® Select product line and/or LATICRETE International, Inc.

*Pricing and minimum order quantities are dependent on color and products. Custom colors are not eligible for return.

+Minimums and lead time apply. Choose from Pantone or RAL color palettes.

CUSTOM COLOR MATCHING
available for:

PERMACOLOR® Select[†] Grout

Profiles & Trims[†]

LATASIL™ Silicone Sealant

NXT® Level Concrete Overlays

Concrete & Substrate Preparation

A quality finished floor starts with a properly prepared surface — one that guarantees a long-lasting, durable installation. LATICRETE® time-tested surface preparation products are formulated to preserve quality. They provide a perfectly level substrate to accommodate a variety of floor finishes including vinyl, wood, carpet, and tile.



Autostrada Club & Showroom

Westport, Connecticut, USA

NXT® Level SP

26 | [laticrete.com](https://www.laticrete.com)

VAPOR BAN™ E
Refer to Data Sheet 36647



A single-coat, 100% solids, liquid applied 2-part epoxy coating specifically designed for controlling the moisture vapor emission rate from new or existing concrete slabs. Protects moisture/pH sensitive floor coverings.

FEATURES/BENEFITS:

- Protects moisture/pH sensitive floor coverings
- Reduces MVER ≤ 25 to below 3 lbs/1000 ft²/24hr (170 µg/(s · m²))
- Exceeds ASTM F3010 standard (<0.1 grains/h/ft²/in. Hg) at only 12 mil thickness
- Safe for use on concrete up to 100% RH / 14 pH
- Oil Tolerant
- Direct replacement for NXT® Vapor Reduction Coating, SPARTACOTE® Moisture Vapor Barrier, and SUPERCAP® Moisture Vapor Coating

PACKAGING:

Full Unit Kit: 5 gal (24.6 L)/24 per pallet

Mini Unit Kit: 3 gal (9.4 L)/24 per pallet

Approximate Coverage			
Vapor Permeance ^a	MVER/RH	mil thickness	ft ² /gal (m ² /L)
0.052 grains/h/ft ² /in. Hg (3 ng/h · m ² · Pa)	≤25 lbs (170 µg)/100%	12	133 (3.2)



VAPOR BAN ER

Refer to Data Sheet 35216



VAPOR BAN™ ER is a rapid curing, single-coat moisture vapor barrier designed for controlling the moisture vapor emission rate from new or existing concrete slabs. A two-part, 100% solids epoxy, it exceeds ASTM F3010 standard with a perm rating of 0.094 grains/h/ft² /in. Hg (5.4 ng/h • m² • Pa). VAPOR BAN ER is oil tolerant and can be applied by squeegee or roller.

FEATURES/BENEFITS:

- Rapid cure as soon as 3 hours
- Protects moisture/pH sensitive floor coverings
- Reduces MVER ≤ 25 to below 3 lbs/1000 ft²/24hr (170 µg/(s • m²))
- Exceeds ASTM F3010 standard (<0.1 grains/h/ft²/in. Hg)
- Safe for use on concrete up to 100% RH / 14 pH
- Oil Tolerant

PACKAGING:

Mini Unit Kit: 3 gal (9.4 L)/24 per pallet

Approximate Coverage

Vapor Permeance ^a	MVER/RH	mil thickness	ft ² /gal (m ² /L)
0.094 grains/h/ft ² /in. Hg (5.4 ng/s • m ² • Pa)	≤25 lbs (170 µg)/100%	16	100 (9.3)



VAPOR BAN Primer ER

Refer to Data Sheet 35222



A single-coat, ASTM F3010 approved, 100% solids, liquid applied 2-part epoxy coating specifically designed for controlling the moisture vapor emission rate from new or existing concrete slabs. It will also perform as a primer prior to installing NXT® and SUPERCAP® self-leveling underlayments. Can be used with multiple LATICRETE tile adhesives as well. It converts two steps into one. VAPOR BAN Primer ER reduces MVER ≤25 to below 3 lbs/1000 ft²/24 hrs (170 µg/(s•m²)).

FEATURES/BENEFITS:

- Rapid cure as soon as 3 hours
- Best in class open time
- Exceeds ASTM F3010 standard (0.094 grains/h/ft²/in. Hg (5.4 ng/s • m² • Pa))
- Reduce MVER ≤25 to below 3lbs/1000ft²/24hrs (170 µg/(s•m²))
- Fast cure self-leveling underlayments in as little as 3 to 4 hours
- Can be used with NXT Overlays - as a primer with sand broadcast for rapid installs

PACKAGING:

Mini Unit Kit: 3 gal (9.4 L)/24 per pallet

Approximate Coverage

Vapor Permeance ^a	MVER/RH	mil thickness	ft ² /gal (m ² /L)
0.094 grains/h/ft ² /in. Hg (5.4 ng/s • m ² • Pa)	≤25 lbs (170 µg)/100%	16	100 (9.3)

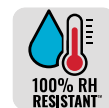

Primer Plus
Refer to Data Sheet 65437



A premium concentrated multi-purpose primer designed to increase bond strength and maximize the performance of self-leveling underlayments and crack isolation peel and stick membranes on multiple interior substrates such as concrete, gypsum, wood, and more.

FEATURES/BENEFITS:

- Universal primer for use with self-leveling underlayments and peel & stick membranes
- Multi-purpose product for use on concrete, wood, and gypsum substrates
- Provides strong adhesion for a longer-lasting application
- Nanoparticles penetrate deep into substrates
- High-performing, concentrate
- Easy to use with a broom, roller, or sprayer for great coverage
- Directly replaces NXT® Primer, SUPERCAP® Primer Plus, and FRACTURE BAN® Primer

PACKAGING:

1 gal (3.8 L) jug, 4 jugs per carton, 28 cartons per pallet
 5 gal (18.9 L) plastic pail, 36 per pallet
 245 gal (927.4 L) heavy-duty intermediate bulk container (IBC)

PRIME-N-BOND™
Refer to Data Sheet 307



Versatile, ready-to-use, single coat, low VOC primer designed to enhance the adhesion of mortars to many smooth and non-absorptive substrates that can be difficult to bond to. PRIME-N-BOND™ also improves bonding of self-leveling underlayments (SLUs) over cementitious substrates.

FEATURES/BENEFITS:

- One Component, ready-to-use, no dilution required
- Single coat application
- Contains aggregate for enhanced mechanical bond
- For use with Polymer Modified adhesives and self-leveling underlayments (SLU's)
- Low voc, low odor
- White color will not darken the back of light colored stone

PACKAGING:

1 gal (3.78 L) pail, 4 pails per carton
 3.5 gal (13.3 L) plastic pail

Primer Plus Dilution / Approximate Coverage

SUITABLE SUBSTRATES	Dilution Ratio = Primer: Water	Approximate Coverage Per Gallon Diluted with Water
Normal Suction: Concrete / Wood	1:3	100 ft ² (9 m ²)
High-Suction: Highly Porous Dry Concrete	1st Coat: 1:5 2nd Coat: 1:3	50 ft ² (5 m ²)
Non-Suction: VAPOR BAN™ / Tile / Stone / Vinyl	1:1 with Slurry	100 ft ² (9 m ²)
FRACTURE BAN® peel and stick membrane substrates	1:1	100 ft ² (9 m ²)

Approximate Coverage

(varies depending on substrate)

1 gal (3.78 L) pail: 150 – 300 ft² (13.9 – 27.9 m²)
 3.5 gal (13.3 L) pail: 525 – 1050 ft² (48.8 – 97.5 m²)



Choose the right Moisture Barrier and Primer for the job.



	Moisture Barriers			Primers		
	BEST	BETTER	GOOD			
	VAPOR BAN™ Primer ER	VAPOR BAN ER	VAPOR BAN E	PRIME-N-BOND™	Primer Plus	General Primer
FEATURES AND BENEFITS						
1 Component				✓	✓**	
2 Component	✓	✓	✓			✓
Rapid	✓	✓				
Can be pigmented (SPARTACOTE)	✓	✓	✓			
Underlayment Application	✓*	✓*	✓*	✓*	✓*	✓*
Overlayment Application	✓*	✓*	✓*			✓*
Tile/ Stone Adhesive Application	✓	✓	✓	✓		
100% RH / ASTM F-3010 / Moisture Barrier	✓	✓	✓			
Can be applied to smooth surface (vinyl, tile, etc.)				✓	✓ (Slurry)	
Low Preparation (Concrete)	✓*			✓*		
1 Gallon				✓	✓	
3 Gallon	✓	✓	✓	✓ (3.5 Gallon)		
5 Gallon			✓		✓	✓
Warranty	Lifetime	Lifetime	Lifetime	Lifetime	Lifetime	1 Year

*Refer to Substrate Preparation and Primer Guide for LATICRETE Self-Leveling Products. **Refer them to the Product Data Sheet.

NXT® Level Plus Lite

Refer to Data Sheet 36656



A premium lightweight, fiber-reinforced, cement-based underlayment designed for leveling a variety of interior projects using concrete, plywood, OSB, or gypsum substrates prior to the application of floor coverings. At nearly half the cured weight of a standard SLU, it's a great option for installations with load-bearing concerns. This versatile, rapid-setting underlayment is pourable and pump-friendly, allows for up to 4" (102 mm) in pour depth, and consistently produces a flat, smooth, and hard surface in as soon as 24 hours.

FEATURES/BENEFITS:

- Reduced cured weight of nearly 50% vs Standard SLU
- Reduced packaging weight of 50% making it safer and easier to carry
- Applicable for use on plywood, OSB, gypsum, and concrete - no metal lath required
- Non-moisture sensitive flooring can be placed at 3 to 4 hours
- No capping is required - Single step placement
- Contains no respirable crystalline silica levels that exceed the OSHA action level†
- High compressive strength of up to 4400 PSI (33.3 MPa)
- 1/8" (3mm) to 4" (102 mm) max pour depth
- Pourable and pump-friendly, free-flowing self leveler
- Long heal times for extended workability
- Microban® Antimicrobial Product Protection fights the growth of mold and mildew in the underlayment

PACKAGING:

27 lb (12.2 kg) bag; 56 bags per pallet

Approximate Coverage	
Nominal Thickness	Approximate Coverage
1/8" (3 mm)	44 ft ² (4.1 m ²)
1/4" (6 mm)	22 ft ² (2.0 m ²)
1/2" (12 mm)	11 ft ² (1.0 m ²)
3/4" (18 mm)	7.3 ft ² (0.6 m ²)
1" (25 mm)	5.5 ft ² (0.5 m ²)
2" (51 mm)	2.7 ft ² (0.3 m ²)
3" (76 mm)	1.9 ft ² (0.2 m ²)
4" (102 mm)	1.4 ft ² (0.1 m ²)

NXT Level Plus

Refer to Data Sheet 505.0



A high quality, cement-based, fiber reinforced, free-flowing underlayment for use in leveling wide variety of substrates including concrete, plywood, OSB and more. Rapid setting formula produces a flat, smooth and hard surface for the installation of finished flooring after 12 hours. NXT Level Plus can be placed up to 2" (51 mm) in a single lift over concrete. Wood based substrates require a minimum of a 1/4" (6 mm) thickness.

FEATURES/BENEFITS:

- Suitable surface for most floor goods as soon as 12 hours
- Pour depth of 1/8" to 2" (3 to 51mm) and tapered to zero at edges on concrete substrates
- Pour depth of 1/4" to 2" (6 to 51mm) on wood substrates
- Can be applied over plywood, Gypsum and OSB without the use of a metal lath
- Low-shrinkage
- High compressive strengths 5300 psi (36.5 MPa)
- Suitable surface for most finished floor goods
- Can be applied directly over concrete testing at RH of 100% or less per ASTM F2170
- Pumpable

PACKAGING:

55 lb (25 kg) bag; 56 bags per pallet

Approximate Coverage	
Nominal Thickness	Approximate Coverage
1/8" (3 mm)	49 ft ² (4.6 m ²)
1/4" (6 mm)	24 ft ² (2.3 m ²)
1/2" (12 mm)	12 ft ² (1.1 m ²)
3/4" (18 mm)	8.1 ft ² (0.8 m ²)
1" (25 mm)	6.1 ft ² (0.6 m ²)
2" (51 mm)	3.0 ft ² (0.3 m ²)

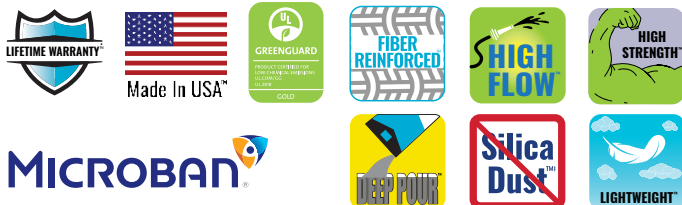

*Coverage will vary depending on the texture of the surface. A survey is also recommended. †OSHA action level set forth in OSHA's Respirable Crystalline Silica (RCS) standard for construction, 29 CFR 1926.1153, as tested by an independent laboratory to be below the OSHA action level for respirable crystalline silica - see laticrete.com/silica. Antimicrobial technology protects the treated article against mold and mildew deterioration. Antimicrobial technology is not designed to replace normal cleaning practices or protect users.

NXT® Level
Refer to Data Sheet 504.0



A cement-based underlayment for use in leveling interior substrates. NXT® Level produces a flat, smooth and hard surface for the installation of finished flooring. NXT Level can be placed from 1/8 – 3" (3 – 76 mm) in a single lift.

FEATURES/BENEFITS:

- Pour depth of 1/8 to 3" (3 to 76 mm) in a single lift
- High compressive strength
- Pourable and pumpable
- Suitable surface for most floor goods as soon as 24 hours
- Inorganic; will not contribute to mold/mildew growth

PACKAGING:

50 lb (22.7 kg) bag; 56 bags per pallet

Approximate Coverage	
Thickness	Coverage
1/8" (3 mm)	44.0 ft ² (4.1 m ²)
3/16" (5 mm)	29.3 ft ² (2.7 m ²)
1/4" (6 mm)	22.0 ft ² (2.0 m ²)
5/16" (8 mm)	17.6 ft ² (1.6 m ²)
3/8" (10 mm)	14.7 ft ² (1.4 m ²)
7/16" (11 mm)	12.6 ft ² (1.2 m ²)
1/2" (12 mm)	11.0 ft ² (1.0 m ²)
9/16" (14 mm)	9.8 ft ² (0.9 m ²)
5/8" (16 mm)	8.8 ft ² (0.8 m ²)
11/16" (17 mm)	8.0 ft ² (0.7 m ²)
3/4" (19 mm)	7.3 ft ² (0.6 m ²)
13/16" (21 mm)	6.8 ft ² (0.6 m ²)
7/8" (22 mm)	6.3 ft ² (0.6 m ²)
15/16" (24 mm)	5.9 ft ² (0.5 m ²)
1" (25 mm)	5.5 ft ² (0.5 m ²)
2" (51 mm)	2.7 ft ² (0.3 m ²)
3" (76 mm)	1.9 ft ² (0.2 m ²)

NXT Level Flow
Refer to Data Sheet 36623



A cement-based, pump friendly, high flowing, easy-to-use underlayment for use in leveling interior substrates. NXT Level Flow produces a flat, smooth and hard surface for the installation of finished flooring

FEATURES/BENEFITS:

- High flowing and easy-to-use
- Pour depth of 1/8" to 2" (3mm to 51mm) and tapered to zero at edges
- Pourable and pumpable
- Inorganic; will not contribute to mold/mildew growth
- Suitable surface for most finished floor goods as soon as 48 hours
- Can be applied directly over concrete testing at RH of 100% or less per ASTM F2170

PACKAGING:

50 lb (22.7 kg) bag; 56 bags per pallet

Approximate Coverage	
Thickness	Coverage
1/8" (3 mm)	44.0 ft ² (4.1 m ²)
3/16" (5 mm)	29.3 ft ² (2.7 m ²)
1/4" (6 mm)	22.0 ft ² (2.0 m ²)
5/16" (8 mm)	17.6 ft ² (1.6 m ²)
3/8" (10 mm)	14.7 ft ² (1.4 m ²)
7/16" (11 mm)	12.6 ft ² (1.2 m ²)
1/2" (12 mm)	11.0 ft ² (1.0 m ²)
9/16" (14 mm)	9.8 ft ² (0.9 m ²)
5/8" (16 mm)	8.8 ft ² (0.8 m ²)
11/16" (17 mm)	8.0 ft ² (0.7 m ²)
3/4" (19 mm)	7.3 ft ² (0.6 m ²)
13/16" (21 mm)	6.8 ft ² (0.6 m ²)
7/8" (22 mm)	6.3 ft ² (0.6 m ²)
15/16" (24 mm)	5.9 ft ² (0.5 m ²)
1" (25 mm)	5.5 ft ² (0.5 m ²)
2" (51 mm)	2.7 ft ² (0.3 m ²)



NXT® Level SP
Refer to Data Sheet 35609



A pourable, high performing self-leveling concrete topping, primarily used to finish interior concrete slabs. As a high-strength wear surface when polished, NXT® Level SP provides a low maintenance, durable solution with an attractive, coarse salt and pepper look. Can be pigmented to custom colors through our AnyColor™ program.

FEATURES/BENEFITS:

- Available in standard colors of Grey and White
- Aggregate rich overlay provides attractive salt and pepper look
- Tintable to coordinate with interior designs
- High abrasion and stain resistance allow for a durable, and low maintenance surface
- Polishable to a finished wear-surface in as little as 24 hours
- Pourable and pumpable
- Full system availability with L&M™ and STONETECH® products

PACKAGING:

50 lb (22.7 kg) bag; 56 bags per pallet

Approximate Coverage	
Thickness	Coverage
1/2" (12.7 mm)	10 ft² (0.9 m²)
3/4" (19.1 mm)	5.8 ft² (0.5 m²)
1" (25.4 mm)	4.7 ft² (0.4 m²)
2" (50.8 mm)	2.3 ft² (0.2 m²)



NXT Level DL
Refer to Data Sheet 029.2



A polishable cement-based, high quality, fast drying, self-leveling, monolithic, interior wear surface topping that can be accented with a wide variety of coloring systems & finishes. Can be pigmented to custom colors through our AnyColor™ program.

FEATURES/BENEFITS:

- Available in standard colors of Grey and White
- Tintable to coordinate with interior designs
- High abrasion and stain resistance allow for a durable, and low maintenance surface
- Polishable to a finished wear-surface in as little as 24 hours
- Pourable and pumpable
- Full system availability with L&M and STONETECH products
- Equipped with Microban® antimicrobial product protection to fight the growth of stain-causing mold and mildew on the surface

PACKAGING:

55 lb (25 kg) bag; 56 bags per pallet

Approximate Coverage	
Thickness	Coverage as a Wear Surface
1/2" (12 mm)	12 ft² (1.1 m²)
3/4" (18 mm)	8 ft² (0.7 m²)
1" (25 mm)	6 ft² (0.6 m²)
2" (51mm)	3 ft² (0.3 m²)



Antimicrobial technology protects the treated article against mold and mildew deterioration. Antimicrobial technology is not designed to replace normal cleaning practices or protect users.

NXT® Patch

Refer to Data Sheet 501.0



A fast-drying underlayment patch for use over most substrates. Cement-based formula is excellent for deep fills from 1/8" - 1 1/2" (3 - 38 mm) per lift.

FEATURES/BENEFITS:

- Easy to mix and apply
- Fast drying – apply finish floor goods in as soon as 40 minutes
- Interior and exterior applications

PACKAGING:

25 lb (11.3 kg) bag/64 bags per pallet

Approximate Coverage	
Thickness	Coverage
1/8" (3 mm)	32.5 ft ² (3.0 m ²)
1/4" (6 mm)	16.3 ft ² (1.5 m ²)
1/2" (13 mm)	8.1 ft ² (0.8 m ²)
1" (25 mm)	4.1 ft ² (0.4 m ²)
1-1/2" (38 mm)	2.7 ft ² (0.3 m ²)



Skim Lite

Refer to Data Sheet 506.0



A premium quality, fast-drying, polymer modified, cement-based underlayment designed for skim coating, smoothing and leveling prior to the application of floor coverings.

FEATURES/BENEFITS:

- Rapid setting formula
- Exterior rated
- High coverage rate
- Fiber reinforced
- Improved adhesion
- Fantastic workability
- Moisture tolerant
- Can be used on concrete with RH levels up to 100%
- Light weight – 40% weight saving
- Apply from skim depth to 1" (25 mm)
- Ready for finished flooring in as soon as 20 minutes
- Direct replacement for NXT® and SUPERCAP® Skim Skimcoat, DRYTEK® Skimcoat

PACKAGING:

8 lb (3.6 kg) bag

Approximate Coverage

Up to 380 ft² (35.3 m²) at skim depth over smooth substrate (Slu/plwood/etc.)

Up to 190 ft² (26.9 m²) at skim depth over rough substrate (Osb/concrete/etc.)





SELF-LEVELING OVERLAYMENTS SELECTION GUIDE

CONCRETE & SUBSTRATE PREPARATION

Choose the right Patch & Repair and Self-Leveling Underlayment for the job.



Self-Leveling Underlayments				Patch & Repair	
NXT® Underlayments				NXT Patch & Repair	
BEST		BETTER	GOOD	BEST	BETTER
NXT® Level Plus Lite	NXT Level Plus	NXT Level	NXT Level Flow	Skim Lite	NXT Patch

FEATURES AND BENEFITS

Max Build in one lift	4" (102 mm)	2" (51 mm)	3" (76 mm)	2" (51 mm)	1" (25 mm)	1.5" (38 mm)
Initial Set Time	30 - 45 minutes	20 - 30 Minutes	20 - 30 Minutes	30 - 45 Minutes	15 minutes	20 - 30 minutes
Final Set Time	45 - 90 minutes	35 - 40 Minutes	35 - 40 Minutes	45 - 120 Minutes	20 minutes	40 - 55 minutes
Walkable	3-4 hours	2-3 hours	2 - 3 Hours	3 - 4 Hours	20 minutes	40 - 55 minutes
Time to install finished goods	24 hours	12 hours	24 Hours	48 Hours	20 minutes	40 - 55 minutes
Multiple substrates	✓	✓			✓	
Microban®	✓	✓			✓	
Compressive Strength	4400 PSI* (30 MPa)*	5300 PSI* (36 Mpa)*	5000 PSI* (34 Mpa)*	4000 PSI* (28 MPa)*	N/A	4000 - 4500 PSI* (28 - 31 MPa)*
Use with STRATA_MAT™/ STRATA HEAT™	✓	✓				
Lightweight Formula	✓				✓	
Fiber Reinforced	✓	✓			✓	
Exterior					✓	✓
100% RH Resistant					✓	✓
Packaging	27 lb. & Super Sack Avail.	55 lb. & Super Sack Avail.	50 lb. & Super Sack Avail.	50 lb. & Super Sack Avail.	8 lbs	25 lbs
Warranty	Lifetime	Lifetime	10 Year	5 Year	Lifetime	Lifetime

*All results are averages. Specifications subject to change without notification. Results shown are typical but reflect test procedures used. Actual field performance will depend on installation methods and site conditions.

Choose the right Self-Leveling Overlay for the job.

	Overlays	
	NXT® Overlays	
	Salt & Pepper Medium Aggregate	Monolithic No Aggregate
	NXT Level SP	NXT Level DL
FEATURES AND BENEFITS		
Max Build in one lift (minimum height is 1/2")	2"	2"
Color	Grey & White (can be tinted)	Grey & White (can be tinted)
Monolithic (No Aggregate)		✓
Aggregate Exposure	✓	
Initial Set	30 - 60 Minutes	30 - 60 minutes
Walkable	2-4 hours	2-4 hours
Time to install finished goods	24 hours	6 hours
Compressive Strength	7000 PSI* (48 MPa)	5100 PSI* (35 MPa)
Polishing Timing	After 24 hours	After 24 hours
Can be used with General Primer, VAPOR BAN™ E or VAPOR BAN ER	✓ (with sand)	✓ (with sand)
Packaging	50 lb. & Super Sack Avail.	55 lb. & Super Sack Avail.
Warranty	1 Year	1 Year

*All results are averages. Specifications subject to change without notification. Results shown are typical but reflect test procedures used. Actual field performance will depend on installation methods and site conditions.

3701 Lite Mortar

Refer to Data Sheet-36590



Contains no respirable crystalline silica and weighs half the amount of a conventional mortars. It can be used in a wide range of applications such as concrete repairs, wall renders and mortar beds.

FEATURES/BENEFITS:

- Light weight: 30 lbs. (13.6 kg.) vs 60 lbs. (27.2 kg.)
- Same coverage as conventional mortars
- Excellent for vertical and overhead applications
- Freeze-thaw compliant: Exterior or Interior
- Polymer fortified: no need for latex additives
- Economical and Versatile: saves time and money
- Time to liquid applied membrane: 72 hours

PACKAGING:

30 lb (13.6 kg) bag; 56 bags per pallet

Approximate Coverage		
Render/Repair	Mortar Bed	Depth
12 ft ² (1.1 m ²)	10 ft ² (0.93 m ²)	0.5" (13 mm)
6 ft ² (0.56 m ²)	5 ft ² (0.46 m ²)	1" (25 mm)
4 ft ² (0.37 m ²)	3 ft ² (0.28 m ²)	1.5" (38 mm)
3 ft ² (0.28 m ²)	2 ft ² (0.19 m ²)	2" (51 mm)



3701 Lite Mortar R (Rapid)

Refer to Data Sheet 36603



This Rapid mortar contains no respirable crystalline silica. It will decrease the wait time significantly in applications such as concrete repairs, wall renders and mortar beds. All while weighing half the amount of a conventional mortar.

FEATURES/BENEFITS:

- Rapid formula: cure time of 2 hours
- Light weight: 30 lbs. (13.6 kg.) vs 60 lbs. (27.2 kg.)
- Same coverage as conventional mortars
- Excellent for vertical and overhead applications
- Freeze-thaw compliant: Exterior or Interior
- Polymer fortified: no need for latex additives
- Economical and Versatile: saves time and money
- Time to liquid applied membrane: 2 hours

PACKAGING:

30 lb (13.6 kg) bag; 56 bags per pallet

Approximate Coverage		
Render/Repair	Mortar Bed	Depth
12 ft ² (1.1 m ²)	10 ft ² (0.93 m ²)	0.5" (13 mm)
6 ft ² (0.56 m ²)	5 ft ² (0.46 m ²)	1" (25 mm)
4 ft ² (0.37 m ²)	3 ft ² (0.28 m ²)	1.5" (38 mm)
3 ft ² (0.28 m ²)	2 ft ² (0.19 m ²)	2" (51 mm)



Quick Cure Mortar Bed

Refer to Data Sheet 1004.0



A rapid setting, polymer fortified, blend of carefully selected polymers, portland cement and graded aggregates.

FEATURES/BENEFITS:

- Ready for foot traffic in as soon as 60 minutes
- No need for latex additives, just add water
- No need for job site measuring and mixing of sand and cement
- Use with HYDRO BAN® Quick Cure for faster shower system installs

PACKAGING:

60 lb (27.2 kg) bag; 56 bags per pallet

Approximate Coverage

14 ft² at 1/2" (1.3 m² at 12 mm)

7 ft² at 1" (0.7 m² at 25 mm)

3.5 ft² at 2" (0.3 m² at 50 mm)



3701 Fortified Mortar

Refer to Data Sheet 100.0



A premium, polymer fortified blend of carefully selected polymers, portland cement and graded aggregates. 3701 Fortified Mortar does not require the use of latex admix, you only need to add water to produce thick bed mortar with exceptional strength and performance.

FEATURES/BENEFITS:

- Premixed – no job site blending of powders required
- Consistent results
- High strength formula
- Pumpable for large scale projects
- Exceeds ASTM C270 requirements
- For use as a scratch or finish coat in place of Type S or Type N mortar

PACKAGING:

60 lb (27.2 kg) bag; 56 bags per pallet

Approximate Coverage

12 ft² at 1/2" (1.1 m² at 12 mm)

6 ft² at 1" (0.56 m² at 25 mm)

3 ft² at 2" (0.3 m² at 50 mm)



3701 Mortar Admix

Refer to Data Sheets 231.0



3701 Mortar Admix is a specially designed latex admixture for use with thin-set mortars, cement grouts, cement mortar beds, and other cement mixes.

FEATURES/BENEFITS:

- For Interior and exterior installations
- Improve shock, chemical and frost resistant
- Increases bond and compressive strength
- Improves water resistant; suitable for submerged applications
- Superior flexibility

PACKAGING:

3701 Mortar Admix:
5 gal (18.9 L) pail
36 pails per pallet

226 Thick Bed Mortar

Refer to Data Sheets 239.1



226 Thick Bed Mortar is a factory prepared blend of carefully selected raw materials, portland cement and graded aggregates. 226 Thick Bed Mortar can be used with 3701 Mortar Admix to produce a latex portland cement mortar that has exceptional strength. Achieving a higher performance level and a Lifetime warranty.

FEATURES/BENEFITS:

- For Interior and exterior installations
- Improve shock, chemical and frost resistant
- Increases bond and compressive strength
- Improves water resistant; suitable for submerged applications
- Superior flexibility

PACKAGING:

226 Thick Bed Mortar:
60 lb (27.2 kg) bag
56 bags per pallet

209 Floor Mud

Refer to Data Sheet 209.0



Mixes with water to provide a conventional floor mortar bed.

FEATURES/BENEFITS:

- Pre-mixed, economical alternative to 226 Thick Bed Mortar
- For interior applications such as shower pan fills in bathrooms

PACKAGING:

60 lb (27.2 kg) bag; 56 bags per pallet

Approximate Coverage

6 ft² (0.56 m²) at 1" (25 mm) thickness
per 60 lb (27.3 kg) bag



Made In USA™

Approximate Coverage

45 ft² (4.2 m²) at 1" (25 mm) thick per 60 lb (27.3 kg) bag



Made In USA™



GREENGUARD
GOLD

Choose the right Mortar for the job.

						
	BEST			BETTER		GOOD
	3701 Lite Mortar Rapid	3701 Lite Mortar	3701 Fortified Mortar Bed	Quick Cure Mortar Bed	226 Thick Bed	209 Floor Mud
FEATURES AND BENEFITS						
ASTM C-627 (Extra Heavy Rating)			✓		✓	
ASTM C-270				✓		
Rapid	✓			✓		
Walkable	1.5 – 2 Hours	16 Hours	16 Hours	1 Hour	12 Hours	12 Hours
Walls	✓ (ideal)	✓ (ideal)	✓		✓	
Greenguard	✓	✓	✓	✓	✓	
Low VOC	✓	✓	✓	✓	✓	✓
Mix with 3701 Mortar Admix					✓	✓
Pot Life	25 – 35 Minutes	2 Hours	2 Hours	30 Minutes	1 Hour	1 Hour
Compressive Strength w/water (PSI (MPA))	2000 to 3000* (14 to 21)	2500 to 3500* (17 to 24)	5000 to 6000* (34 to 41)	3000 to 4000* (21 to 28)	3000 to 4000* (21 to 28)	2000 to 2300* (14 to 16)
Compressive Strength w/water and 3701 Mortar Admix (50/50) (PSI (MPA))						2200 to 2500* (15 to 17)
Compressive Strength w/3701 Mortar Admix (100%) (PSI (MPA))					4000 TO 5000* (28 TO 34)	2500 TO 3000* (17 TO 21)
Crystalline Silica Free [†]	✓	✓				
Lightweight Formula	✓	✓				
Polymer Modified	✓	✓	✓	✓		
Warranty	Lifetime	Lifetime	Lifetime	Lifetime	1 Year	1 Year
WHERE TO USE						
Exterior	✓	✓	✓	✓	✓**	
Submerged	✓	✓	✓	✓	✓**	
Steam/High Humidity	✓	✓	✓	✓		✓
Exterior Façade	✓	✓	✓		✓	
Vehicular Traffic			✓		✓	
Heavy Commercial			✓		✓	
Light Commercial	✓	✓	✓		✓	✓
Residential	✓	✓	✓	✓	✓	✓

*All results are averages. Specifications subject to change without notification. Results shown are typical but reflect test procedures used. Actual field performance will depend on installation methods and site conditions.**Requires 3701 ADMIX to be used.

†OSHA action level set forth in OSHA's Respirable Crystalline Silica (RCS) standard for construction, 29 CFR 1926.1153, as tested by an independent laboratory to be below the OSHA action level for respirable crystalline silica - see laticrete.com/silica.

Pro-Mix Station



A successful job depends on optimized mixing time, reduced spillage, and consistent results of the end-product. The Pro-Mix Station provides an ideal and safe solution to meet these demands. As a pourable cart, the Pro-Mix Station contains the material, eliminates harmful dust, and provides combined batch consistency. The removable drill allows for the mixing of tile/stone adhesive and repair mortars. The Pro-Mix Station can be used with many LATICRETE® products, such as self-leveling underlayments, overlays, and epoxies.

FEATURES/BENEFITS:

- 3 bag capacity handles up to 1500 lb (680 kg)/hr output
- 14.5 amp/110 V drill has a powerful electric motor
- 2-speed drill (250 RPM and 580 PRM) can adjust based on product consistency
- 2 mixing paddles provide the ability to mix a wide product range
- Rotating caster wheels for easy mobility
- Tilttable and easy to pour
- Dust extractor helps prevent harmful dust particles from being inhaled
- Steel frame for longevity
- Replacement liners available: 7319-LINER-CR

Pro-Kart



The Pro-Kart when paired with the Pro-Mix Station provides an ideal and safe solution to allow for continuous mixing, optimal placement, and reduced spillage. Keep the job moving and let the Pro-Kart handle the delivery. The Pro-Kart can be used with many LATICRETE products, such as self-leveling underlayments, overlays, and epoxy coatings.

FEATURES/BENEFITS:

- 20 gallon (75.7 L) bin capacity
- Rotating caster wheels for easy mobility
- Tilttable and easy to pour
- Dust extractor helps prevent harmful dust particles from being inhaled
- Steel frame for longevity

Underlayment Tool Kit



Be ready to tackle any NXT® and SUPERCAP® self-leveling underlayment/overlay application with this high quality tool kit. Achieving smooth and consistent results on any project. No matter how big or small, LATICRETE has you covered.

TOOL KIT* INCLUDES:

- 15 gallon (56.8 L) mixing barrel
 - Slip-in spiked shoes in size large
 - Gauge rake frame and rake set
 - Gauge rake set
 - Spiked roller with frame
 - Oval mixing paddle
 - Spreader smoother
 - 2 quart (1.9 L) measuring container
 - 3 piece pole
- *Kit is sold as a whole unit. Not available separately.



NIVCOMP Digital Level



A surveying tool to determine floor flatness and help you to calculate the correct amount of self leveling underlayment material needed for your job. This tool can be used with SUPERCAP® and NXT® products from LATICRETE.

FEATURES/BENEFITS:

- Rugged self-contained kit is light, portable, compact and easy to set up and use
- Single person operation
- Durable and easy to use hose reel – 157 ft (47.8 m) hose range is abrasion and crush resistant
- All-inclusive – requiring no tripods, transits, bubble levels or lasers
- Versatile and accurate [within +/- 5/64" (2 mm)] to work around corners – no line-of-sight required
- Measures height differences in "blind areas", flatness (level) and variable elevations

LATICRETE NIVCOMP DIGITAL LEVEL INCLUDES:

- Rugged, protective case
- Self-leveling device (reel, hose, handheld display unit)
- Rods
- Cradle
- Magnet attachment for overhead work
- End cap
- Operators manual

Elevation Pins



Customizable pins ensure your self-leveling underlayments pour will be to a specific, accurate depth. This tool can be used with SUPERCAP and NXT products from LATICRETE.

FEATURES/BENEFITS:

- Memory plastic snaps back — if bent, self-adhesive strip keeps pins in place
- Minimize waste by pouring self-leveling underlayments to a specific, accurate depth
- Dual measurement indicator marks in both inches and millimeters
- When used in conjunction with the NIVCOMP™, simply read the proper height on the NIVCOMP then cut the LEVEL PEG to match
- Time saver — very fast and flexible to learn and use

QUANTITY:

1,000 pins per box

SIZE:

2-1/2" (64 mm)

Plaza & Deck System



Tile Drain Mat

Refer to Data Sheet 290.0

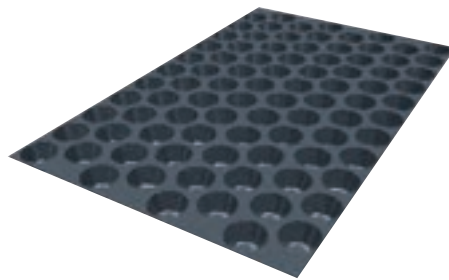

A component of the Plaza and Deck System, this lightweight subsurface mat drains infiltrated water and reduces the potential for mineral deposits.

FEATURES/BENEFITS:

- Provides three times the drainage rate of a conventional 2" (50 mm) crushed gravel bed
- Extra Heavy service rating per ASTM C627 TCNA)

PACKAGING:

- 200 ft² (19 m²)
- 6 rolls per pallet
- 30 lbs/roll (13.6 kg/roll)
- 230 lbs/pallet (104.3 kg/pallet)

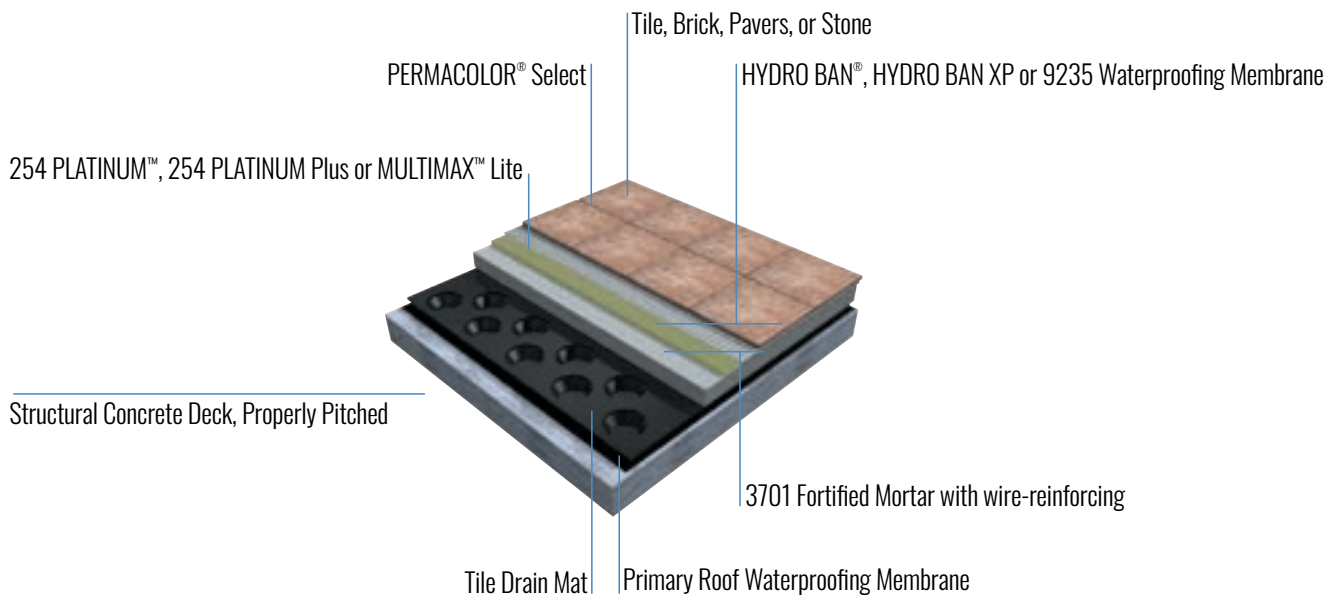



Waterproofing & Shower Systems

HYDRO BAN® Sheet Membrane

Refer to Data Sheet 041.0



Two convenient roll sizes for large and small installations. Can be used in steam showers as a vapor barrier/waterproofing membrane.

FEATURES/BENEFITS:

- Easy to cut and embed — conforms easily to irregular substrates
- Durable polypropylene surface fused to the core for optimal bond strength and integrity
- Allows for usage of polymer-modified or unmodified mortar — use proper mortar for the job
- Code approved; meets ANSI A118.10

Available Sizes

3'3" x 98'5" = 323 ft² (1 m x 30 m = 30 m²)

38 rolls per pallet

3'3" x 33' = 108 ft² (1 m x 10 m = 10 m²)

120 rolls per pallet

**HYDRO BAN Sealing Tape**

Refer to Data Sheet 041.0



5" (125 mm) width available in two convenient roll lengths to meet project needs.

FEATURES/BENEFITS:

- Easy to cut and embed — conforms easily to irregular substrates
- Durable polypropylene surface fused to the core for optimal bond strength and integrity
- Allows for usage of polymer-modified or unmodified mortar — use proper mortar for the job
- Code approved; meets ANSI A118.10
- 5" x 16'5" (125 mm x 5 m) individually packaged 12 per carton
- 5" x 98'5" (125 mm x 30 m) individually packaged 1 per carton

Available Sizes

5" x 16'5" (125 mm x 5 m)
individually packaged – 12 per carton

5" x 98'5" (125 mm x 30 m)
individually packaged – 1 per carton



HYDRO BAN® Prefomed Corners

Refer to Data Sheet 041.0

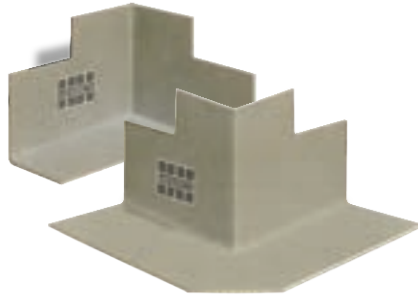

HYDRO BAN® Prefomed Corners make waterproofing fast, easy and reliable. Use in conjunction with HYDRO BAN Sheet Membrane, Sealing Tape and Collars.

FEATURES/BENEFITS:

- Sturdy and pliable, conforms easily

PACKAGING:

Inside Corners: 2 per package – 12 per carton

Outside Corners: 2 per package – 12 per carton

**HYDRO BAN Collars and Mixing Valve Seal**

Refer to Data Sheet 041.0

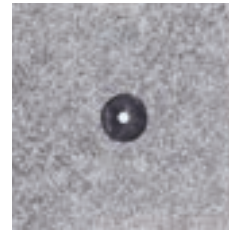

Pipe Collar

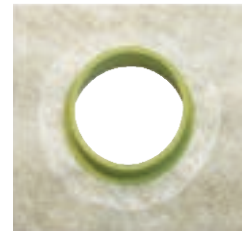

Mixing Valve

Pre-formed to ensure an easier and more secure installation. (Can also be used with HYDRO BAN® liquid applied waterproofing membrane.) Use in combination with HYDRO BAN Board for steam showers.

FEATURES/BENEFITS:

- Interior applications
- Showers or tub surrounds
- Complete line of accessories — single source supply

PACKAGING:

3/4" (20 mm) Pipe Collar – 1 per bag

4-1/2" (114 mm) Mixing Valve, 10 per carton

Available Sizes

3/4" (20 mm) Pipe Collar for use with 1/2" - 3/4" pipe (12.7 - 20 mm) packaged individually, 12 per carton

4-1/2" (114 mm) Mixing Valve Collar packaged individually, 10 per carton



HYDRO BAN® Drain Collars

Refer to Data Sheet 080.7



The HYDRO BAN Deep Drawn Drain Collars are available in 3/4" (19 mm) and 1-1/2" (38 mm) depths and a 17" (43 cm) diameter.

Preformed drain collars are designed to use with HYDRO BAN Sheet Membrane when a shower pan is installed using 3701 Fortified Mortar Bed or similar materials. The HYDRO BAN Drain Collar enables the installer to easily waterproof a shower pan when using a divot method with mortar around a clamping ring drain assembly.

FEATURES/BENEFITS:

- Interior applications
- Typically waterproofed shower pans
- Easily conforms around clamping ring assembly

PACKAGING:

HYDRO BAN Deep Drawn Drain Collars 3/4" (19 mm),
10 per carton

HYDRO BAN Deep Drawn Drain Collars 1 1/2" (38 mm),
10 per carton

**HYDRO BAN Accessories**

Refer to Data Sheet 065.0, 064.0, 061.0, 063.0

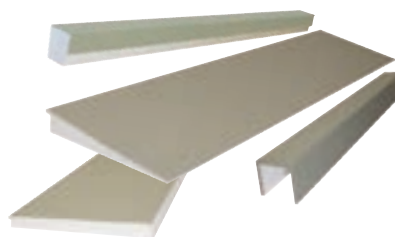

A wide range of accessories are available for the HYDRO BAN® Pre-Sloped Shower Pan. These accessories are all components of the expanded HYDRO BAN line of waterproof products that allow for high quality rapid shower installations. All of the HYDRO BAN Shower Pan Accessories are constructed of lightweight high-density expanded polystyrene with a waterproof finish and are ready to tile.

FEATURES/BENEFITS:

- Lightweight, high-density expanded polystyrene
- Waterproof finish
- Ready to tile

HYDRO BAN PRE-SLOPED EXTENSION

- The HYDRO BAN Pre-Sloped Extension comes 24" x 48" (61 x 122 cm) and can be added on to the HYDRO BAN Pre-Sloped Shower Pans with a center drain location when a larger pan is required.

HYDRO BAN PRE-SLOPED RAMP

- The HYDRO BAN Pre-Sloped Ramp has a 1" in 8" (2.5 cm in 20 cm) slope and can be used for ADA compliant showers with all HYDRO BAN Pre-Sloped Shower Pans having a center drain location

HYDRO BAN PREFORMED CURBS

- The HYDRO BAN Preformed Curbs are available in a full foam 5' (152 cm) length. Custom sizes available with a 3 week lead time from receipt of site drawing and Purchase Order. Contact your local LATICRETE Sales Rep for further information.

HYDRO BAN PREFORMED OVERLAY CURBS

- The HYDRO BAN Preformed Overlay Curbs are available in 4' (122 cm) and 8' (244 cm) lengths and are designed to fit over a traditional 2" x 4" (5 x 10 cm) curb construction.



HYDRO BAN® Shower Pans



HYDRO BAN Shower System Kits



The HYDRO BAN® Shower Pan Kit provides a cost effective solution for waterproofing shower applications. The shower installation kit includes all the key components for a waterproof shower. Available in multiple sizes, it fits almost any application where a pre-sloped shower is required – industrial, commercial and residential bathrooms, as well as stalled gang showers and pet showers.

The Shower Pan Kit comes packaged with the following accessories: Data Sheet, Shower Pan, Curbs to fit the longest side of pan, Adhesive and Sealant (10.3 fl. oz. cartridge), Sheet Membrane for walls, Sheet Membrane for pan, Sealing Tape for installation, 4 Inside Corners, 2 Outside Corners, 1 Pipe Seal, 1 Mixing Valve Seal and 2 Bonding Flange Drain Rings. HYDRO BAN Bonding Flange Drains are sold separately. (Not compatible with the tile in version).

FEATURES/BENEFITS:

- Pre-sloped shower pan eliminates the need for traditional mud bed installations
- Lightweight and durable, easy to transport and handle during shower installation
- Can quickly and easily be modified to size on site
- For peace of mind installs, the sheet membrane exceeds ANSI A118.10 requirements, is IAPMO approved and is tested to ASTM E96/E96M Procedure E-0.06 Perms — approved for steam showers/steam rooms as single membrane
- Membrane is pliable to conform easily to any substrate.
- Do it your way — allows installers to finish walls using HYDRO BAN Board or, HYDRO BAN Waterproofing and HYDRO BAN Sheet Membrane over cement backer board

PACKAGING:

Carton Packaging – Varies per size

Available Sizes	Item Number
38" x 38" Center Drain Pan	9243-3838-CDP
48" x 48" Center Drain Pan	9243-4848-CDP
48" x 48" CDP Barrier-Free	9243-4848-CDP-BF
72" x 72" Center Drain Pan	9243-7272-CDP
48" x 72" Center Drain Pan	9243-4872-CDP
32" x 60" Center Drain Pan	9243-3260-CDP
32" x 60" Off-Center Drain Pan	9243-3260-OCDP

PACKAGING:

Carton Packaging – Varies per size

Available Sizes	Item Number
38" x 38" Center Drain Kit	9243-3838-CDK
48" x 48" Center Drain Kit	9243-4848-CDK
72" x 72" Center Drain Kit	9243-7272-CDK
48" x 72" Center Drain Kit	9243-4872-CDK
32" x 60" Center Drain Kit	9243-3260-CDK



HYDRO BAN® Pre-Sloped Shower Pan

Refer to Data Sheet 031.0



HYDRO BAN® Pre-Sloped Shower Pan is a component of the expanded HYDRO BAN line of products that allow for high quality rapid shower installations. Constructed of lightweight high-density expanded polystyrene, the HYDRO BAN Pre-Sloped Shower Pan comes with a factory installed drain/waste line connection, is 100% waterproof, and ready-to-tile. The HYDRO BAN Drain Grates are sold separately in brushed, polished and oil rubbed bronze finishes.

Each pre-sloped shower pan is packaged with one HYDRO BAN Pre-Sloped Shower Pan, one HYDRO BAN Preformed Curb and a tube of HYDRO BAN Adhesive and Sealant. All pans are available with either a PVC, ABS or BRS (Brass) drain connection where the plumbing code stipulates the use of a metal based waste line connection.

FEATURES/BENEFITS:

- Comes with a factory installed drain/waste line connection and drain assembly
- Pre-sloped, ready-to-tile pan — no need for traditional mud bed installations
- Can quickly be modified to size on site
- Factory installed, code-approved waterproofing meets ANSI A118.10 requirements
- Code approved: meets IAPMO-PS-106
- Available in custom sizes

Available Sizes

36" x 60" (91 cm x 152 cm) PVC, ABS or BRS center drain
36" x 48" (91 cm x 122 cm) PVC, ABS or BRS center drain
48" x 60" (122 cm x 152 cm) PVC, ABS or BRS center drain
48" x 48" (122 cm x 122 cm) PVC, ABS or BRS center drain
38" x 66" (96 cm x 168 cm) PVC, ABS or BRS off center drain

Custom sizes available with 4 week lead time

HYDRO BAN Drain Grates are sold separately.



HYDRO BAN Linear Pre-Sloped Shower Pan

Refer to Data Sheet 085.0



HYDRO BAN Linear Pre-Sloped Shower Pan is a component of the expanded HYDRO BAN line of products that allow for high quality rapid shower installations. Constructed of lightweight high-density expanded polystyrene, the HYDRO BAN Linear Pre-Sloped Shower Pan allows for the combination of HYDRO BAN Linear Drains and Pre-Sloped Shower Pans. The HYDRO BAN Linear Pre-Sloped Shower Pans are 100% waterproof, and ready-to-tile. The HYDRO BAN Linear Drains are sold separately in brushed, polished, oil rubbed bronze finishes and a tile-in version to enhance the shower design. Each pre-sloped shower pan is packaged with one HYDRO BAN Linear Pre-Sloped Shower Pan, one HYDRO BAN Preformed Curb and a tube of HYDRO BAN Adhesive & Sealant. Custom sizes available with a 4 week lead time from receipt of site drawing and Purchase Order. Contact your local LATICRETE Sales Rep for further information.

FEATURES/BENEFITS:

- Pre-sloped ready to tile pan eliminates need for traditional mud bed installations
- Factory installed, code approved waterproofing meets ANSI A118.10 requirements
- The length can quickly and easily be modified to size on site
- Code approved, Meets IAPMO-PS- 106
- Works in conjunction with LATICRETE tile and stone installation materials

Available Sizes

LINEAR PRE-SLOPED SHOWER PAN SIZES	APPLICABLE LINEAR DRAIN SIZES
34" x 66" (86 cm x 168 cm)	32" (81 cm)
38" x 66" (97 cm x 168 cm)	36" (91 cm)
44" x 66" (112 cm x 168 cm)	42" (107 cm)
50" x 66" (127 cm x 168 cm)	48" (122 cm)

Custom sizes available with 4 week lead time

HYDRO BAN Linear Drains are sold separately.



HYDRO BAN® Preformed Bench

Refer to Data Sheet 067.0



HYDRO BAN® Preformed Bench is a component of the expanded HYDRO BAN line of waterproofing products that allow for high quality rapid shower installations. The HYDRO BAN Preformed Bench is made from lightweight, high-density expanded polystyrene with a waterproof finish. The HYDRO BAN Preformed Benches are 100% waterproof and ready-to-tile. Can be installed anywhere a tiled bench is needed. Simple to install; ready-to-tile. All HYDRO BAN Preformed Benches are 20" (51 cm) in height. Custom sizes available with a 4 week lead time from receipt of site drawing and Purchase Order. Contact your local LATICRETE Sales Rep for further information.

FEATURES/BENEFITS:

- Lightweight, high-density expanded polystyrene with a waterproof finish
- Simple to install; ready to tile
- Can be installed anywhere a tiled bench is needed

Available Sizes

11" x 11" (28 cm x 28 cm)

35" x 11.5" (89 cm x 29 cm) rectangle

HYDRO BAN Preformed Bench is 20" (51 cm) high

Custom sizes available with a 4-week lead time



HYDRO BAN Preformed Seats

Refer to Data Sheet 032.0



HYDRO BAN Preformed Seats are components of the expanded HYDRO BAN line of waterproof products that allow for high quality rapid shower installations. HYDRO BAN Preformed Seats are made from high-density expanded polystyrene with a waterproof finish. The HYDRO BAN Preformed Seats are 100% waterproof and ready-to-tile.

All HYDRO BAN Preformed Seats are 20" (51 cm) high.

FEATURES/BENEFITS:

- High-density expanded polystyrene with a waterproof finish
- Lightweight and strong
- Ready-to-tile, waterproof surface
- Easy to install

Available Sizes

11" x 11" (28cm x 28cm) triangle

16" x 16" (41 cm x 41 cm) triangle

23" x 23" (58 cm x 58 cm) triangle

11" x 11" (28cm x 28cm) convex

16" x 16" (41 cm x 41 cm) convex

All HYDRO BAN Preformed Seats are 20" (51 cm) high



HYDRO BAN® Preformed Niches

Refer to Data Sheet 033.0



HYDRO BAN® Preformed Niche is a component of the expanded HYDRO BAN line of waterproof products that allow for high quality rapid shower installations. HYDRO BAN Preformed Niche is constructed of lightweight, high-density expanded polystyrene with a waterproof finish and is ready to tile. Custom sizes available with a 4 week lead time from receipt of site drawing and Purchase Order. Contact your local LATICRETE Sales Rep for further information.

FEATURES/BENEFITS:

- Lightweight, strong, high-density, expanded polystyrene
- Simple to install
- Ready-to-tile, waterproof surface
- Ideal for bathrooms and kitchens

Available Sizes

12" x 12" (30 cm x 30 cm) square

12" x 12" & 12" x 6"
(30 cm x 30 cm & 30 cm x 15 cm)

8" x 8" (20 cm x 20 cm) square

8" x 12" (20 cm x 30 cm) and
8" x 6" (20 cm x 15 cm) narrow combo

12" x 20" (15 cm x 51 cm) mega



HYDRO BAN Board

Refer to Data Sheet 040.0



HYDRO BAN board is a lightweight construction panel designed to be used in bonded tile or stone installations. It is made with a high-density, waterproof foam core and a reinforced, waterproof membrane on both sides. Available in a variety of thicknesses from 1/4" to 2" (6 mm to 50 mm) the HYDRO BAN board can be used as a substrate for tile and stone on walls or floors, as well as in many installations requiring dimensionally sound and stable substrates. The HYDRO BAN board can be secured to wood or steel wall framing studs using the coated hydro ban board screws at 1 5/8", 2" or 3" (41, 50 or 150 mm), depending on the board thickness. Tab washers are only required for ceiling installations.

When purchasing HYDRO BAN Board the minimum order is per bundle (see chart for sheets per bundle at each thickness). If a full pallet of board is ordered along with separate bundles of other thicknesses three bundles (any thickness) can be stacked on top of the pallet for delivery. Bundles that cannot be stacked on a full pallet will be palletized separately. Up to 8 bundles of any thickness combination can be loaded per pallet.

FEATURES/BENEFITS:

- Lightweight, easy to carry — save on labor and freight
- Heavy duty waterproof membrane with XPS core — triple protection from water intrusion and ready to tile
- Low permeability — approved for steam rooms and steam showers
- No tab washers required for floors and walls — faster, less expensive installation

HYDRO BAN Board is priced by the sheet but sold by the bundle.

Additional Sizes and Packaging 3' x 5' (91 x 152 cm)

THICKNESS	SHEETS PER PALLET	SHEETS PER BUNDLE
1/4" (6 mm)	84	21
1/2" (13 mm)	60	10
5/8" (16 mm)	50	10
1" (25 mm)	30	5
2" (50 mm)	15	3

Additional Sizes and Packaging 4' x 8' (122 x 244 cm)

1/2" (13 mm)	55	5
--------------	----	---

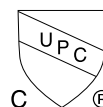

HYDRO BAN® Linear Drains

Refer to Data Sheet 034.0

Grate and trough sold separately.

Tile-In Linear Drain



Off-Set Oval



Brushed Steel Linear Drain



Polished Steel Linear Drain



Oil Rubbed Bronze Steel Linear Drain



Matte Black Steel Linear Drain



NEW

HYDRO BAN® Linear Drains are available in a tile-in version providing a seamless continuous tiled floor appearance – virtually making the drain disappear and an attractive brushed, polished or oil rubbed bronze finish offset oval design. Also, available in the HYDRO BAN Linear Drain line is the wedge wire in brushed and polished finishes. Ideal for large format tile or stone installations for shower floors installed along the wall or at intermediate locations. The HYDRO BAN Linear Drain is a two piece drain with a trough and removable grate **sold separately**. These linear drains are available with a standard vertical waste line a horizontal side outlet or a with a threaded connector (to connect to a clamping ring assembly) in eight standard lengths.

FEATURES/BENEFITS:

- Allows for use of large format tile and a single slope to the drain
- Tile in grate available to match floor tile
- Eliminates pre-slope and primary shower pan for a faster installation
- Made from heavy duty 304 stainless steel provides for long lasting performance
- HYDRO BAN waterproofing membrane bonds directly to stainless steel flange edge allowing for faster, easier installation

Custom sizes are available with a 4 week lead time from receipt of site drawing and purchase order. Contact your local LATICRETE Sales Representative for further information.



Wedge Wire



Brushed Steel



Polished Steel

Side Outlet Linear Drain



All Sold Separately



LINEAR DRAIN "T" Trough

LINEAR DRAIN SIDE OUTLET Trough



LINEAR DRAIN THREADED CONNECTOR TROUGH

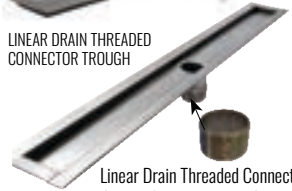

Linear Drain Threaded Connector designed to connect to clamping ring drain assemblies. Trough

HYDRO BAN® Linear Drain Sizes

24" (61 cm)
30" (76 cm)
32" (81 cm)
36" (91 cm)
42" (107 cm)
48" (122 cm)
54" (137 cm)
60" (152 cm)
Custom sizes also available

Offset oval grate comes in brushed, polished, or oil-rubbed bronze finish. Wedge Wire grate is available in brushed and polished finish. Available with a vertical outlet, or a side outlet as a special order.

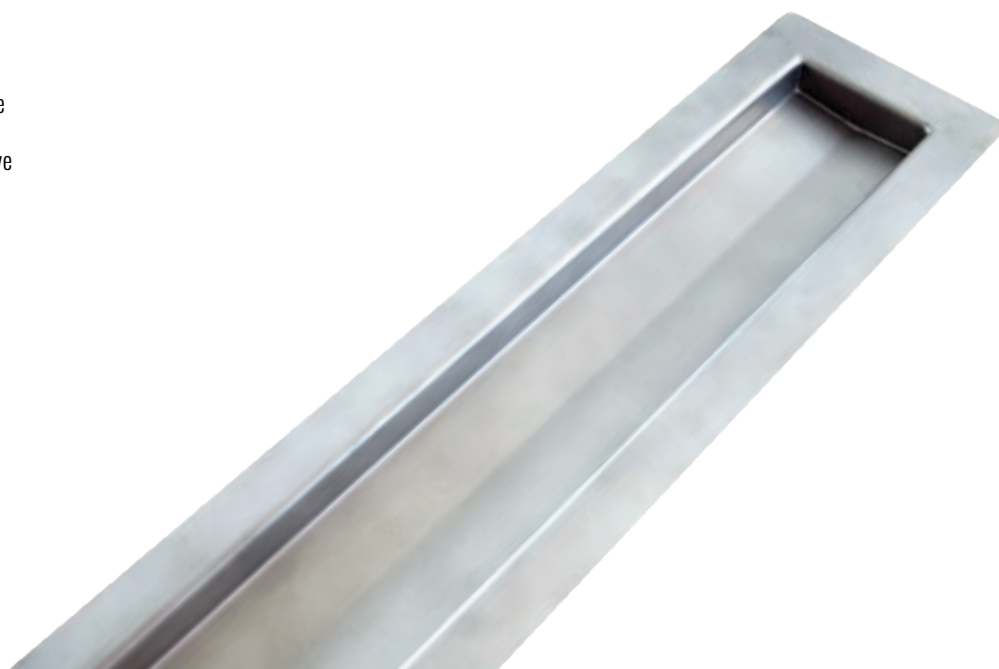

HYDRO BAN® Bonding Flange Drains

Refer to Data Sheet 035.0

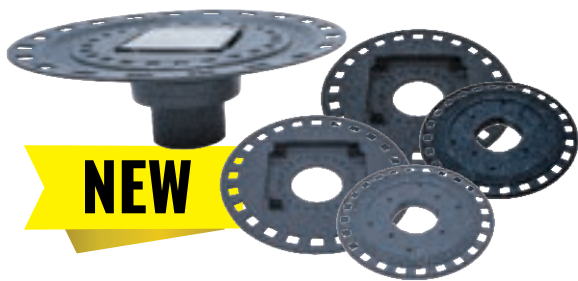

Comprised of a flange body, adjusting ring, and stainless steel drain assembly. Compatible with LATICRETE mortar bed and HYDRO BAN® liquid applied on Sheet Membrane for a complete waterproof assembly.

FEATURES/BENEFITS:

- All drain grates constructed of heavy duty 304 stainless steel to resist wear and scratching
- Bonding flange body available in PVC or ABS
- Adjusts both vertically and laterally for easy installation
- Polished, brushed and oil rubbed bronze grates are a low profile design suitable for tile thicknesses of 1/4" – 1-1/2" (6 mm – 38 mm), depending on grate design
- Code approved per ASME A112.18-2-2005/GSA B125.2.05 (US and Canada)
The stainless steel Bonding Flange is available for use where the plumbing code stipulates the use of a metal based waste line connection. The Stainless Steel Bonding Flange comes with the flange and adjusting ring. The drain grate is purchase separately.

PACKAGING:

Carton packaging

HYDRO BAN® Bonding Flange	Description	Item Number
PVC (Flange Only)	BFD Only	9248-0BFD-P2
ABS (Flange Only)	BFD Only	9248-0BFD-A2
PVC - Polished Point Drain	Grate Only	9248-0404-PS
PVC - Brushed Point Drain	Grate Only	9248-0404-BS
PVC - Matte Black Point Drain	Grate Only	9248-0404-MB
PVC - ORB Point Drain	Grate Only	9248-0404-MB
PVC Flange - Polished Point Drain	Kit - Grate + BFD	9246-0404-PSP2
PVC Flange - Brushed Point Drain	Kit - Grate + BFD	9246-0404-BSP2
PVC Flange - Matte Black Point Drain	Kit - Grate + BFD	9246-0404-MBP2
PVC Flange - ORB Point Drain	Kit - Grate + BFD	9246-0404-ORBP2
PVC Flange - Tile-in Point Drain	Kit - Grate + BFD	9246-0404-TIP2
PVC Flange (10 Pack - Flange/Adjusting Ring Only)	Kit - Grate + BFD	9248-0BFDP10
ABS Flange (10 Pack - Flange/Adjusting Ring Only)	Kit - Grate + BFD	9248-0BFDA10
PVC Flange (PS 10 Pack - Grates & Flanges)	Kit - Grate + BFD	9246-0404PSP10
PVC Flange (BS 10 Pack - Grates & Flanges)	Kit - Grate + BFD	9246-0404BSP10
PVC Flange (MB 10 Pack - Grates & Flanges)	Kit - Grate + BFD	9246-0404MBP10
PVC Flange (ORB 10 Pack - Grates & Flanges)	Kit - Grate + BFD	9246-0404ORBP10
PVC Flange (TI 10 Pack - Grates & Flanges)	Bulk BFD Pack	9246-0404TIP10

HYDRO BAN Point Drain

Refer to Data Sheet 069.0



HYDRO BAN Point Drains are low profile point drains specifically designed for use with the HYDRO BAN Pre-Sloped Shower Pan. The grates are available in brushed, polished or oil rubbed bronze stainless steel. The HYDRO BAN Drain Grate can also be used in other areas requiring standard drain grate installations (i.e. with standard clamping ring drains).

FEATURES/BENEFITS:

- Available in multiple finishes to match your other plumbing fixtures
 - Code approval per ASME A 112.18-2 / CSA B125.2.05 (US and Canada)
 - Component of LATICRETE Lifetime Warranty. Single source responsibility
 - Works in conjunction with HYDRO BAN Pre-Sloped Shower Pan and other clamping ring style drains
- * See DS 230.99 for complete warranty information.

PACKAGING:

Carton packaging

HYDRO BAN® Point Drains	Item Number
PVC - Polished Point Drain	9248-0404-PS
PVC - Brushed Point Drain	9248-0404-BS
PVC - Matte Black Point Drain	9248-0404-MB
PVC - ORB Point Drain	9248-0404-MB



*Bonding Flange Drain Kit Only

HYDRO BAN® XP

Refer to Data Sheets DS-36642 and 10003



A thin waterproofing anti-fracture membrane that combines optimum performance and unmatched productivity. HYDRO BAN® is rapid drying allowing for a faster tiling time and flood testing in just 2 hours* after final cure, as well as faster flood testing in cold temperatures and over mortar beds. Save yourself time and money, and complete your installations faster with greater ease.

FEATURES/BENEFITS:

- Flood test in 2 hours*
- Improved flood testing over fresh mortar beds and at cooler temperatures
- No fabric required in coves or corners*
- IAPMO and ICC approved
- Anti-fracture protection up to 1/8" (3 mm)
- Easy to clean with water

PACKAGING:

Commercial Unit: 5 gal (18.9 L) pail liquid 36 units per pallet
 Mini Unit: 4 x 1 gal (3.8 L) pails of liquid packed in a carton
 30 cartons per pallet

Approximate Coverage	
1 gal pail	50 ft ² (4.6 m ²)
5 gal pail	250 ft ² (23.2 m ²)
275 gal tote	13,750 ft ² (1,277 m ²)



MICROBAN®

^ See Data Sheet 230.05 for complete warranty information. * Interior application (non-wet areas only) ** If skim coated with a LATICRETE® latex thin-set mortar. *** Consult cement backer board manufacturer for specific installation recommendations and to verify acceptability for exterior use. † HYDRO BAN® XP can be flood tested in 2 hours when the waterproofing membrane is cured and the substrate is 70°F (21°C) and 50% RH or greater for 2 hours. The 2 hour period starts when the HYDRO BAN color has changed from a sage green to a dark olive green color indicating a cured membrane. If the substrate and the air temperature are lower than 70°F (21°C) and 50% RH, flood testing can not be performed until the HYDRO BAN XP color has changed from a sage green to dark olive green color and then 24 hours has lapsed. Antimicrobial technology protects the treated article against mold and mildew deterioration. Antimicrobial technology is not designed to replace normal cleaning practices or protect users.

HYDRO BAN

Refer to Data Sheet 663.0 and 663.5



A premium thin, load bearing waterproofing/crack isolation membrane that does not require the use of fabric in field areas, coves and corners[†]. It can be used in both interior and exterior as well as residential and commercial applications.

FEATURES/BENEFITS:

- Steam shower and steam room rated
- Flood test in 2 hours at 70 F (21 C) and 50% RH[†]
- No fabric required
- IAPMO and ICC approved
- Anti-fracture protection of up to 1/8" (3 mm)

PACKAGING:

Commercial Unit: 5 gal (18.9 L) pail liquid 36 units per pallet
 Mini Unit: 4 x 1 gal (3.8 L) pails of liquid packed in a carton
 30 cartons per pallet

Approximate Coverage	
1 gal pail	50 ft ² (4.6 m ²)
5 gal pail	250 ft ² (23.2 m ²)
275 gal tote	13,750 ft ² (1,277 m ²)

In addition to the conventional means of applying HYDRO BAN, the airless spraying technique can be used as an alternate means of application. HYDRO BAN can be effectively sprayed to increase productivity up to three times or four times on large projects. Any airless sprayer can be used that will deliver up to 3300 PSI (22.8 MPa) using a maximum tip size of 0.031" (0.79 mm). See TDS 410 for further information on the application of HYDRO BAN with an airless sprayer.



HYDRO BAN Quick Cure Waterproofing

Refer to Data Sheets 670.4



A rapid, thin, liquid applied ready-to-use waterproofing membrane that is ANSI A118.10 Compliant. Featuring Wet-Cure technology, this allows curing even in humid, cold and damp environments. HYDRO BAN Quick Cure allows for flood testing in as soon as 30 minutes[†] allowing contractors to install a shower system all in one day.

FEATURES/BENEFITS:

- Interior and exterior
- Shower pans, stalls and tub surrounds
- Thin: only 0.012" (0.3 mm) thick when cured
- Wet-Cure Technology - Can be used in humid, cold and damp environments.
- Allows for flood testing in 30 min. at 70°F (21°C) or higher

PACKAGING:

1 gal (3.8 L) Pail

Approximate Coverage	
1 Gallon Unit: 134 ft ² /gal (12.4 m ² /3.8 L)	



[†] See Data Sheet 663.0 for complete product information. HYDRO BAN[®] can be flood tested in 2 hours when cured at 70°F (21°C) or above and 50% R.H. It can be flood tested in 24 hours when cured at 50 - 69°F (10 - 20.6°C) and up to 70% R.H. The time to flood testing starts when the second coat has completely cured from a light sage green to a darker olive green color.

Antimicrobial technology protects the treated article against mold and mildew deterioration. Antimicrobial technology is not designed to replace normal cleaning practices or protect users.

9235 Waterproofing Membrane

Refer to Data Sheets 236.0 and WPAF.5



A thin, load-bearing waterproofing designed specifically for the special requirements of ceramic tile, stone and brick installations. A self-curing liquid rubber polymer and a reinforcing fabric are quickly applied to form a flexible, seamless waterproofing membrane that bonds to a wide variety of substrates.

FEATURES/BENEFITS:

- Industry approved as a shower pan liner
- Provides anti-fracture protection up to 1/8" (3 mm)
- Can be installed using a paint roller or brush
- Meets LEED and VOC requirements
- Interior and exterior

PACKAGING:

Full Unit:

6 gal (22.7 L) pail of liquid
1 carton Waterproofing/Anti-Fracture Fabric, packed separately; 36 units per pallet

Mini Unit:

2 gal (7.6 L) jug of liquid and Waterproofing/Anti-Fracture Fabric, packed together in one pail
48 pails per pallet

Approximate Coverage	
Per Full Unit	300 ft ² (27.9 m ²)
Per Mini Unit	75 ft ² (7 m ²)



HYDRO BARRIER™ Plus

Refer to Data Sheet 36640



A thin, load bearing waterproofing/crack isolation membrane for interior and exterior applications. It can be easily applied with a paint brush, roller or airless sprayer.

FEATURES/BENEFITS:

- Approved by IAPMO for use as shower pan liner
- No fabric required
- Allows for flood testing in 12 hours†
- Anti-fracture protection up to 1/8" (3 mm)
- IAPMO and ICC approved

PACKAGING:

Full Unit:

3.5 gal (13.2 L) pail liquid; 48 full units per pallet

Commercial Unit:

5 gal (18.9 L) pail liquid 36 units per pallet
4 x 1 gal (3.8 L) pails of liquid packed in a carton

Approximate Coverage	
Per Full Unit	175 ft ² (16.2 m ²)
Per Commercial Unit - 5 gal	250 ft ² (23.2 m ²)
Per Commercial Unit - 1 gal	50 ft ² (4.6 m ²)



† Allow HYDRO BARRIER™ Plus to cure fully before flood testing, typically 12 hours at 70°F (21°C) and 50% RH. Cold and/or wet conditions will require a longer curing time. For temperatures 45 – 69°F (7 – 21°C) allow 3 days prior to flood testing.

HYDRO BAN® Cementitious Waterproofing Membrane

Refer to Data Sheet 628.7



A one component, polymer fortified, cement based waterproofing material that mixes only with water. HYDRO BAN Cementitious Waterproofing Membrane handles negative and positive hydrostatic pressure up to 2 BARS (29 PSI) when applied at 40 Mils (1 mm) thick. Flood test within 2 hours. Passes ANSI A118.10 Waterproofing.

FEATURES/BENEFITS:

- Interior and exterior
- Designed for use in swimming pools, fountains, water features, spas and hot tubs
- Flood testing in 2 hours at 70°F (21°C) or higher
- Can be used under pool plasters
- Bonds directly to metal, PVC and ABS plumbing fixtures
- Anti-fracture protection of up to 1/8" (3 mm)
- Exceeds ISO 13007-5 CMP

PACKAGING:

30 lb (13.6 kg) Bag

Approximate Coverage

At 40 mil (1 mm) Thick - 120 ft² (11.2 m²)



LATAPOXY® Waterproof Flashing Mortar

Refer to Data Sheet 070.0



A 3-component epoxy-based flashing to waterproof seams, gaps, or joints between a substrate, metal and PVC pipes, drains, and flashing..

FEATURES/BENEFITS:

- For use under ceramic tile, stone, or brick
- For rapid installations that require a fast-curing waterproof flashing
- Easy to apply using a trowel

PACKAGING:

3.5 gal (13.2 L) pail with 2 Part A 1.4 lbs. (0.65 kg),
2 Part B 1.15 lbs (0.5 kg) and 2 Part C 5.5 lbs. (2.5 kg);
48 units per pallet

Unit contains LATAPOXY® Waterproof Flashing Mortar Part A 2.7 lbs (1.2 kg),
LATAPOXY Waterproof Flashing Mortar Part B liquids 2.3 lbs (1.0 kg), and
LATAPOXY Waterproof Flashing Mortar Part C filler powder 11 lbs (5.0 kg)
conveniently packed in a 3.5 gal (13.2 L) mixing pail.

Approximate Coverage

45 ft²/unit (4.2 m²) at 1/8" (3 mm) thick,
depending on application



MICROBAN®

HYDRO BAN® Board Accessories

Refer to Data Sheet 040.0



Components of the HYDRO BAN® line of waterproof products for rapid shower installations.

FEATURES/BENEFITS:

- Ceramic coated screws — pass 1000 hour salt spray testing
- Two tab washer for easier installation
- When installing HYDRO BAN Board 1 5/8" (41 mm) screw should be used with 1/4" (6 mm), 1/2" (12.7 mm) and 5/8" (16 mm) thick HYDRO BAN Board, 2" (50 mm) screw should be used with 1" (25 mm) thick board and a 3" (76 mm) screw with 2" (50 mm) thick board.

HYDRO BAN Board screws are priced and sold by the box.

Accessories

1-1/4" (32 mm) tab washer, 250 count

1-5/8" (41 mm) screw, 250 count

3" (150 mm) screw, 250 count

LATICRETE® Flashing Sealant

Refer to Data Sheet 36617



LATICRETE® Flashing Sealant is a single component, fast curing, hybrid elastomeric adhesive that is specifically formulated to meet today's Green Building Standards. Offering excellent adhesion on a wide variety of substrates, it simplifies air and watertight details in both new and existing construction allowing for same day installations.

FEATURES/BENEFITS:

- Excellent bond strength – will not peel, chip or bubble from substrates
- Contribute to overall building energy efficiency — Helps maintain heating and cooling requirements for the building structure
- Meets ASTM D 1970 Nail Sealability requirements — Helps prevent infiltration of air and moisture
- Safe — no solvents and non-flammable
- No harmful VOC's

PACKAGING:

20 oz (592 ml) Sausage Pack

Approximate Coverage

Approximately 49 lineal feet (14.9 m) per sausage pack at 1/4" x 1/4" (6 x 6 mm) joint width

**HYDRO BAN Adhesive & Sealant**

Refer to Data Sheet 108.0



HYDRO BAN Adhesive and Sealant is a one component, fast curing, hybrid elastomeric adhesive and sealant. This product is specifically formulated to meet today's Green Building Standards and has excellent adhesion on a wide variety of substrates.

For use with all of the HYDRO BAN Shower System products and accessories..

FEATURES/BENEFITS:

- Excellent adhesion on a variety of substrates
- For use with the HYDRO BAN line of shower system products including seams and penetrations for HYDRO BAN BOARD

Can be used with HYDRO BAN Board to join and cover seams, coves, corners and cover screw and tab washer penetrations.

PACKAGING:

Cartridges available in 10.3 oz (305 ml) tubes, 6 tubes per carton. Sausage packs available in 20 oz (592 ml). Packed 20 sausage packs per carton



A blurred photograph of people walking in a modern building with large glass windows and a polished floor. The image is split horizontally by a teal banner containing the title. The top half shows people in motion against a background of large glass windows. The bottom half shows the lower legs and feet of people walking on a highly reflective, polished floor.

Uncoupling & Anti-Fracture Membranes

STRATA_MAT™
Refer to Data Sheet 026.0

STRATA_MAT XT
Refer to Data Sheet 028.0

**NEW
SIZE**



The Next Generation Uncoupling Mat for use under residential and commercial ceramic tile and stone installations, replacing traditional underlayment materials. Enhances the mechanical bond of adhesive mortar for faster drying and shorter wait times for grouting. Available in the standard STRATA_MAT™ 1/8" (3 mm) version and STRATA_MAT XT 5/16" (8 mm) thickness. Use STRATA_MAT XT when installing typical 1/4" to 3/8" (6 to 9 mm) thick tile adjacent to 3/4" (19 mm) hardwood flooring.

FEATURES/BENEFITS:

- Eliminates transmission of in-plane substrate cracks of up to 1/8" (3 mm)
- Lightweight, easy to carry, and fast to install with standard tools
- Use the appropriate mortar for the tile; polymer modified or unmodified mortar
- Moisture Sensitive Tile and Stone, allows for installation of green marble and moisture sensitive stones with LATAPOXY® 300 thin-set mortar

PACKAGING FOR STRATA_MAT:

- 323 ft² roll — 45" x 86' (30 m² — 1.1 m x 26.2 m) 12 rolls per pallet
- 150 ft² roll — 45" x 40' (13.9 m² — 1.1 m x 12.2 m) 20 rolls per pallet
- Roll — 54 ft² roll — 45" x 14' 3" (5 m² - 1m x 4.3m)
- 10 ft² sheet — 10 ft² (0.9 m²) — 45" x 32" (1.14 m x 0.8 m)

NEW

PACKAGING FOR STRATA_MAT XT:

- 150 ft² roll — 45" x 40' (13.9m² — 1.1m x 12.2 m) 6 rolls per pallet

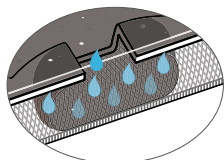

Mortar Hydration Vents

Accelerates thin-set curing for faster dry time of porcelain and larger format tiles — grout the next day

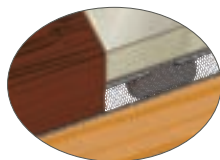

STRATA_MAT XT

At 5/16" (8 mm) thick STRATA_MAT XT creates an even transition between typical 1/4" to 3/8" (6 to 9 mm) thick tile and 3/4" (19 mm) thick hardwood flooring.

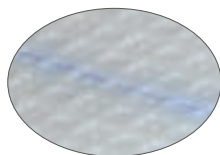

Easy Layout

Chalk lines are easily visible

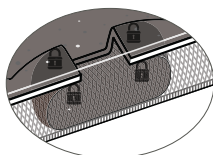

Mechanical Bond

Thin-set mortar forms a mechanical bond to STRATA_MAT™ surface for greater strength



Instant Coverage Verification

Translucent color indicates proper mortar coverage



[©] United States Patent No.: 9,016,018B2 (and other Patents).

FRACTURE BAN®

Refer to Data Sheet 155.0



A high performance, pliable, light weight peel and stick membrane designed for use under ceramic tile, stone and other hard surface installations. This reinforced high strength membrane performs as an anti-fracture and an acoustical underlayment system that eliminates the transmission of stresses from the substrate while dampening the transmission of impact and air borne noise through the floor to the room below. The unique design of this peel and stick membrane allows for usage in both commercial and residential settings where a quick dependable turnaround is required on interior installations. Available in both 40 mil (1.0 mm) and 90 mil (2.3 mm) thicknesses, must be installed on a clean substrate primed using Primer Plus.

FEATURES/BENEFITS:

- Hot-applied polymer modified asphaltic adhesive coated on a 100% polyester non-woven with a 60# release liner paper
- Has a white surface for easy chalk line identification
- Acts as a water resistive barrier
- Anti-Fracture: helps to prevent the transmission of horizontal in plane cracks from the substrate, up to 3/8" (9.5 mm), transmitting up through the tile and stone.
- Sound control: FRACTURE BAN™ 40 has a Δ IIC of 14 and FRACTURE BAN 90 a Δ IIC of 17 through independent ASTM E2179 testing.

PACKAGING:

One roll of FRACTURE BAN® 40 is 40 mils (1 mm) thick
39.25 in. x 69 ft (1 m x 21 m)
24 rolls per pallet.

One roll of FRACTURE BAN 90 is 90 mils thick (2.3 mm)
39.25 in. x 30.6 ft (1 m x 9.33 m)
24 rolls per pallet.

Approximate Coverage

One roll of FRACTURE BAN® 40 covers 225 ft² (20.9 m²)

One roll of FRACTURE BAN 90 covers 100 ft² (9.3 m²)



FRACTURE BAN® SC

Refer to Data Sheet 544.0



A thin, load bearing, self-curing liquid rubber polymer that can be easily applied in a single coat to form a flexible seamless anti-fracture membrane.

FEATURES/BENEFITS:

- Exceeds ANSI A118.12
- Anti-fracture protection of up to 1/8" (3 mm) over shrinkage and other non-structural cracks
- Rapid drying for a faster time to tile
- Single coat application

PACKAGING:

3.5 gal (13.2 L) pail
36 units per pallet

Approximate Coverage

175 ft² (16.2 m²)/unit at wet coat thickness
30 - 44 mils (0.8-1.2 mm)



MICROBAN®

125 TRI MAX®
Refer to Data Sheet 024.0



The new 125 TRI MAX® is a single component material that you spread, set tile or stone and grout in as little as 5 hours. No special latex or containers just add water to mix. 125 TRI MAX - no other thin-set allows for a faster, more economical method of installing tile or stone. It contains a special combination of latex, rare rubber fillers and reinforcing fibers for strength, giving it the ability to do what the others can't do - provide tremendous anti-fracture protection and sound deadening performance.

FEATURES/BENEFITS:

- Anti-fracture and sound reduction in one step — install tile fast reducing labor and material cost by 15 to 20%
- Single component (just add water) making it easy to mix, spread and use
- Lightweight, 50 lb (22.7 kg) coverage in a 25 lb (11.3 kg) bag
- 36% post-consumer recycled content contributes to LEED
- Fiber reinforced producing a stronger bond
- Heavy per ASTM C627 Robinson Floor Test — TCNA so you can use it in high traffic areas

PACKAGING:

25 lb (11.3 kg) bags

COVERAGE:

73-82 ft² (6.8-7.6 m²) per bag with 1/4" x 1/4" (6 mm x 6 mm) trowel
 49-54 ft² (4.6-5.0 m²) per bag with 1/4" x 3/8" (6 mm x 9 mm) trowel
 37-41 ft² (3.4-3.8 m²) per bag with 1/2" x 1/2" (12 mm x 12 mm) trowel

Approximate Coverage

175 ft² (16.2 m²)/unit at wet coat thickness
 30 - 44 mils (0.8-1.2 mm)

1 	2 	3
Adhesive	Sound Control	Anti-fracture

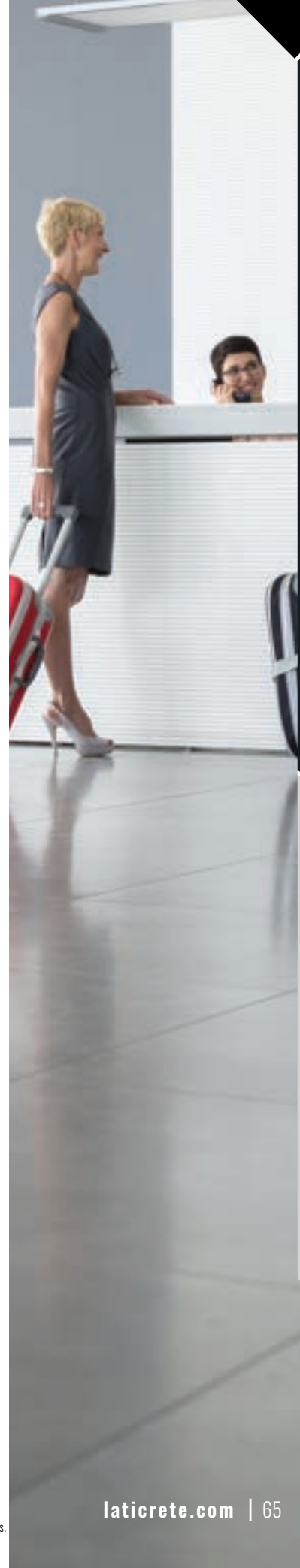

170.3 Sound & Crack Isolation Mat

Refer to Data Sheet 170.0



A 1/8" (3 mm) thick underlayment membrane that provides sound reduction and anti-fracture protection for tile or stone installations.

FEATURES/BENEFITS:

- ΔIIC rating – 16 per ASTM E2179
- Isolates cracks up to 1/8" (3 mm)
- "LIGHT RATING" per ASTM C627 (TCNA)
- Contains 90% post consumer recycled content

PACKAGING:

150 ft² (13.9 m²) roll, 20 rolls per pallet

Approximate Coverage

150 ft² (13.9 m²)



170.5 Sound & Crack Isolation Mat

Refer to Data Sheet 35615.0



170.5 Sound & Crack Isolation Mat is a high performance acoustical underlayment system that muffles impact noises through ceramic tiles, stone and other hard surfacing materials. It also minimizes the transmission of cracks from the substrate to the tile installation up to 1/8" (3 mm) non-movement cracks. 170.5 Sound & Crack Isolation Mat is a 5 mm thick rubberized membrane comprised of 90% post-consumer recycled materials.

FEATURES/BENEFITS:

- ΔIIC rating – 22 per ASTM E2179
- IIC rating - 50 per ASTM E492/E989
- Isolates cracks up to 1/8" (3 mm)
- "Moderate RATING" per ASTM C627 (TCNA)
- Contains 90% post consumer recycled content

PACKAGING:

4 ft x 30 ft (120 ft²), [1.2 m x 9.1 m (11.1 m²)] roll

Approximate Coverage

120 ft² (11.1 m²)



Blue 92 Anti-Fracture Membrane and Crack Suppression Kit

Refer to Data Sheets 647.0, 648.0, and WPAF.5



A 2-part system that forms a flexible, full-coverage membrane that reduces crack transmission from the substrate to floor finishes.

FEATURES/BENEFITS:

- Easy to install: cleans up with water
- EXTRA heavy service rating per ASTM C627 (TCNA)
- Passes ANSI A118.12 anti-fracture performance up to 1/8" (3 mm)

PACKAGING:

Kit: 2 gallon (7.6 L) jug of liquid, 1 each 15" (38 cm) wide roll of LATICRETE Waterproofing/Anti-Fracture Fabric packed together in one carton: 36 cartons per pallet.

Full Unit: 5 gallon (19 L) pail liquid; 1 carton LATICRETE Waterproofing/Anti-Fracture Fabric, packed separately, 36 units per pallet.

Approximate Coverage

75 linear ft/unit (23 m) at 15" (37.5 cm) wide

300 ft² (28 m²) per full unit



Product	Sound Control	Anti-Fracture	Waterproofing	Vapor Barrier	Recycled Material	Anti-Microbial	Greenguard
Crack Supression Kit		✓				MICROBAN®	✓
Blue 92 Anti-Fracture Membrane		✓				MICROBAN®	✓
FRACTURE BAN® SC		✓				MICROBAN®	
HYDRO BARRIER™ Plus		✓	✓			MICROBAN®	✓
9235 Waterproofing Membrane		✓	✓			MICROBAN®	✓
HYDRO BAN® Cementitious Waterproofing Membrane		✓	✓				✓
HYDRO BAN Quick Cure		✓	✓				✓
HYDRO BAN		✓	✓			MICROBAN®	✓
HYDRO BAN XP		✓	✓	✓		MICROBAN®	✓
FRACTURE BAN 40	✓	✓					
FRACTURE BAN 90	✓	✓					
170.3 Sound & Crack Isolation Mat	✓	✓			✓	✓	
170.5 Sound & Crack Isolation Mat	✓	✓			✓	✓	
STRATA_MAT™		✓					✓
STRATA_MAT XT		✓					✓
125 TRI MAX®	✓	✓				✓	✓

Refer to applicable Data Sheet for specific installation instructions.

Turn up the HEAT.



STRATA_HEAT™
Thermostat with
Wi-Fi Compatibility



STRATA_HEAT
Smart Wi-Fi Thermostat with
High-Resolution LCD Screen

Radiant Floor Heating

STRATA_HEAT™ Thermal Pack

Utilizing Thermal Diffusion Technology™, heat generated from the STRATA_HEAT™ Spliceless Wire is uniformly distributed throughout the adhesive, providing faster floor heat-up!

STRATA_HEAT Spliceless Wire

The spliceless design speeds up installation eliminating the need to cut the mat or subfloor to bury the cold lead.



[Scan for more information.](#)

STRATA_HEAT Mat

This uncoupling mat easily and securely holds the wire and allows for a variety of spacing combinations.



STRATA_HEAT™ Floor Heating System

Transform bathrooms, shower floors, hallways, kitchens, and more into a warm, cozy, energy-efficient experience.



STRATA_HEAT™ Mat

Refer to Data Sheet 026.1
Installation Instructions Data Sheet 026.1



STRATA_HEAT™ Mat combines the comfort of floor heating wire with the advantages associated with an uncoupling membrane. Warm your tile floor and enhance the mechanical bond to the substrate. STRATA_HEAT Mat will provide faster drying of the mortar while allowing for shorter time to grout. At the same time it will easily hold the STRATA_HEAT Wire in 2, 3 or 4 peg positions for floor heating or warming installations. Just like our other uncoupling membranes it is specifically designed for use with both modified and unmodified mortars, you can use the appropriate mortar for the installation.

FEATURES/BENEFITS:

- U.S. Patented Nos. 9,777,931; 10,006,644; 10,215,423; D806,280; and patents pending. mortar hydration vents accelerate thin-set curing for faster dry time of porcelain and larger format tiles – grout the next day
- STRATA_HEAT Mat design maximizes thin-set to wire contact producing a faster heat-up time with even heat distribution
- STRATA_HEAT Spliceless Wire installs easily in mat — lays flat and secure
- Optical coverage verification — translucent features allows for easy determination of mortar coverage

PACKAGING:

161 ft² (15 m²) roll – 39" W x 49' 6" L (1 m x 15 m) sheet
30.3" x 3'3" (0.7 m x 1 m) per sheet, 10 sheets per box
30.3" x 3'3" (0.7 m x 1 m) per sheet, 50 sheets per pack

10 Sheets: 8.6 ft² (0.79 m²)
Each sheet: 39"W x 31" L (1 m x .79 m)
50-Sheet Pack: 43 ft² (3.95 m²)
Each sheet: 39"W x 31" L (1 m x .79 m)



STRATA_HEAT Spliceless Wire

Refer to Data Sheet 026.2
Installation Instructions Data Sheet 044.6

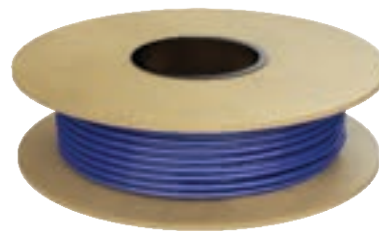

STRATA_HEAT Spliceless Wire is a versatile floor heating wire designed for use under tile and stone to provide luxury and comfort. STRATA_HEAT Spliceless Wire can be used with the STRATA_HEAT Mat or STRATA_HEAT Spacing Strips to meet all of your floor heating needs. It is available in 120 or 240V and fifteen convenient lengths.

FEATURES/BENEFITS:

- No minimum on a straight run length like other systems – easier to layout
- Spliceless design, single diameter throughout the length of the wire
- Highly conductive copper wiring provides maximum heat transfer

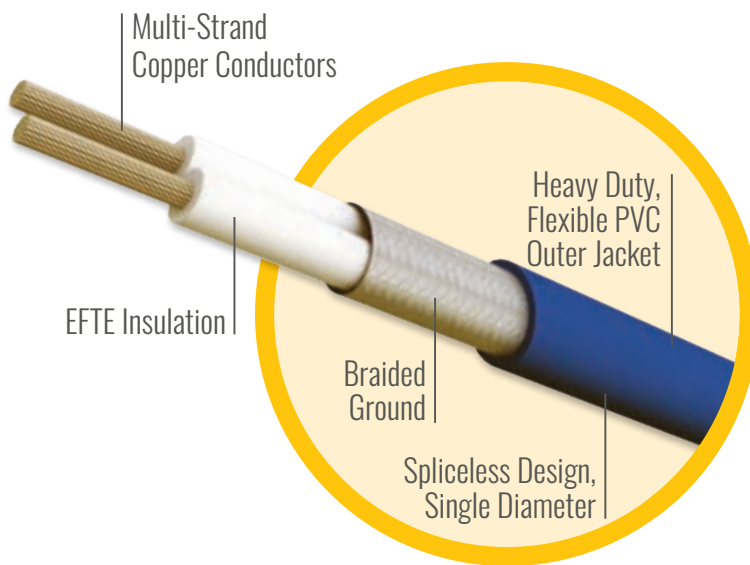



STRATA_HEAT™ Thermostats

Refer to Data Sheets DS-36649

Refer to Data Sheets DS-36648



STRATA_HEAT SMART LCD WIFI THERMOSTAT

The STRATA_HEAT™ Smart LCD Thermostat is a dual voltage 120V/240V thermostat that used both traditionally and through our favorite Smart device; it features a capacitive LCD touch-screen, a single-set up set process and number of other customizable settings that focus on functional and efficiency.

FEATURES/BENEFITS:

- Smartphone Compatible - WiFi enabled
- High Resolution capacitive LCD touch screen
- Reduced Wi-Fi load pull
- Customizable interface
- Single step set-up through QR code
- Smart home compatibility

STRATA_HEAT WIFI THERMOSTAT

The STRATA_HEAT WiFi Thermostat is a dual voltage 120V/240V thermostat that used both traditionally and through our favorite Smart device; it features a touch-panel LCD display, a single-set up set process and number of other customizable settings that focus on functional and efficiency.

FEATURES/BENEFITS:

- Smartphone Compatible - WiFi enabled
- Reduced Wi-Fi load pull
- Customizable display
- Single step set-up through QR code
- Smart home compatibility

PACKAGING:

Smart LCD WiFi 120V/240V

WiFi Thermostat 120V/240V

STRATA_HEAT™ Thermal Pack

Refer to Data Sheet 107.7



Available only from LATICRETE. The world's first patent pending additive designed exclusively for use in select LATICRETE adhesives. Utilizing Thermal Diffusion Technology™ heat from the STRATA_HEAT™ Wire, is uniformly distributed throughout the adhesive, providing faster floor heat-up and a more comfortable and energy efficient installation.

FEATURES/BENEFITS:

- Eliminates cold spots between wires – thermal heat diffusion is increased by 20% – providing uniform warmth for more comfort
- Reduces energy costs by 15% – since heat is transferred faster and more uniformly to achieve desired floor temp – number of heating cycles are reduced, saves money
- Economical and energy efficient – STRATA_HEAT Thermal Pack pays for itself in months by lowering electrical utilization costs

PACKAGING:

3 lb (1.36 kg) Bag contains (2) Thermal Packs



STRATA_HEAT™
Thermal Pack



Infrared image using standard tile adhesive shows cold spots between wires

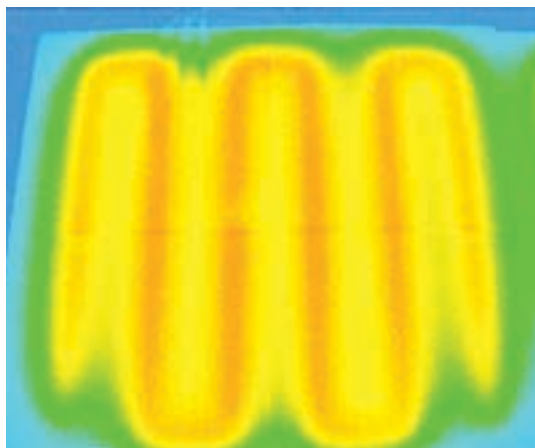

Infrared image using STRATA_HEAT™ Thermal Pack¹ diffuses heat uniformly throughout — no cold spots



Tile & Stone Adhesives & Mortars



LATAPOXY® 310 Stone Adhesive

Refer to Data Sheets 679.0 and 679.3



A strong, two-component epoxy adhesive for spot-bonding tile and stone on vertical surfaces. Easier and faster than traditional methods of veneer installation.

FEATURES/BENEFITS:

- Fast Permanent Bond—45 minutes to 1 hour set time
- Superior stone adhesive for vertical spot bonding installations
- Easy to Use—1:1 mixing ratio by volume
- Non-Staining—ideal for white and light colored marbles, other stones and tiles
- Withstands shock and vibration
- Durable permanent bond, will not deteriorate over time
- Safe—no solvents
- Non-Sag—when applied up to 1" (25 mm) thick
- Rapid version is available; 5–8 minute set up
- Conforms to EN 12004 and ISO 13007 with a classification of R2T

PACKAGING:**Full Unit Kit:** 2.6 gal (10 L):

All components packed in one carton

1.3 gal (5 L) Part A pail, 1.3 gal (5 L) Part B pail

40 cartons per pallet, Available in standard and rapid version

Mini Unit Kit: 2 gal (8 L): units packed in one carton

8 mini jars of Part A 0.5 qt (0.5 L), 8 mini jars of

Part B 0.5 qt (0.5 L), 40 cartons per pallet

Available in standard and rapid versions

Cartridge Packs: 2.3 gal (9 L) Cartridge Pack

(for use in LATAPOXY® 310 Cordless Mixer):

15 x 20 oz (600 ml) cartridge packs of

Part A and Part B per carton, 27 cartons per pallet

Available in standard and rapid versions

MIXING:

Combine equal volumes of Part A and Part B (1:1).

**LATAPOXY 310 Cordless Mixer**

Refer to Data Sheet 683.0



This dual-component mixer quickly dispenses LATAPOXY® 310 Stone Adhesive onto tile, porcelain, and stone veneers.

FEATURES/BENEFITS:

- Triples productivity of vertical stone and tile installations
- Install hundreds of square feet per day
- Design and gear systems allow speed and dosing control
- No mixing — just insert the dual component cartridge, screw on the mixing nozzle, and pull the trigger

PACKAGING:

1 LATAPOXY 310 Cordless Mixer per carton:

24 cartons per pallet

Approximate Coverage

Inches (or millimeters) Out of Plumb	LATAPOXY 310 Stone Adhesive Thickness	2.6 gal (10 L) Full Units
Plumb Wall (3 mm)	1/8" Thick (3 mm)	300 - 325 ft ² (27 - 30 m ²)
1/4" (6 mm)	1/4" Thick (6 mm)	150 - 170 ft ² (14 - 16 m ²)
1/2" (12 mm)	1/2" Thick (12 mm)	75 - 80 ft ² (7 - 7.5 m ²)

SHIPPING LIMITATION: All shipments via ground only, no air shipment allowed.

LATAPOXY® 300 Adhesive

Refer to Data Sheet 633.0



A high-strength, three-part, 100% solids epoxy adhesive formulated for chemical-resistant installations of quarry tile, brick, and packing house tile.

FEATURES/BENEFITS:

- Exceeds ISO 13007-R2
- Water cleanable
- No flammable solvents are required to clean tools or finished work
- Ideal for installing moisture sensitive marble and agglomerate tiles
- Ideal for the installation of resin backed tile, mosaics, agglomerates and stone
- Non-staining on white and light-colored marble
- High bond strength
- Maximum chemical resistance
- Conforms to ISO 13007 with an R2 Classification

PACKAGING:

All components packed in one pail; 48 pails per pallet
Makes 1.8 gal (6.8 L) of mortar

Shipping limitation: All shipments via ground only,
no air shipment allowed.

Approximate Coverage

NOTCH TROWEL	COVERAGE
1/16" (1.5 mm) V-notch	125 - 135 ft ² (11.6 - 12.5 m ²)
1/8" x 1/8" (3 x 3 mm) Square	60 - 70 ft ² (5.6 - 6.5 m ²)
3/16" (4 mm) V-notch	40 - 50 ft ² (3.7 - 4.6 m ²)
1/4" x 1/4" (6 x 6 mm) Square	30 - 35 ft ² (2.8 - 3.3 m ²)

**LATAPOXY BIOGREEN™ 300 Adhesive**

Refer to Data Sheet 023.0



An industry first – a high-strength, chemical resistant epoxy adhesive for installing tile and stone, made with bio-based material. Bio-based materials are derived from plants and other renewable agricultural, marine, and forestry materials. These products provide an alternative to conventional non-renewable materials such as petroleum derived products, contribute to a cleaner environment and may contribute to LEED V4 points BIOGREEN 300 offers the performance you have come to rely on from LATAPOXY® 300 Adhesive with the additional enhancement of a faster cure time. BIOGREEN 300 is designed for your most demanding installations of tile and stone, exceeding both ANSI A118.3 and ISO 13007 R2 requirements for epoxy adhesives.

FEATURES/BENEFITS:

- Exceeds ISO 13007-R2
- Water cleanable
- No flammable solvents are required to clean tools or finished work
- Ideal for installing moisture sensitive marble and agglomerate tiles
- Ideal for the installation of resin backed tile, mosaics, agglomerates and stone
- Non-staining on white and light-colored marble
- High bond strength
- Maximum chemical resistance
- Conforms to ISO 13007 with an R2 Classification
- Made with Biobased materials

PACKAGING:

All components packed in one pail; 48 pails per pallet
Makes 1.9 gal (7.2 L) of mortar

Shipping limitation: All shipments via ground only, no air shipment allowed.

Approximate Coverage

NOTCH TROWEL	COVERAGE
1/16" (1.5 mm) V-notch	125 - 135 ft ² (11.6 - 12.5 m ²)
1/8" x 1/8" (3 x 3 mm) Square	60 - 70 ft ² (5.6 - 6.5 m ²)
3/16" (4 mm) V-notch	40 - 50 ft ² (3.7 - 4.6 m ²)
1/4" x 1/4" (6 x 6 mm) Square	30 - 35 ft ² (2.8 - 3.3 m ²)



272 Mortar
Refer to Data Sheet 259.0



A cementitious powder for ceramic tile and stone installations.

FEATURES/BENEFITS:

- Can be mixed with either water or latex additive
- For increased performance and flexibility, mix with 333 Flexible Additive

PACKAGING:

50 lb (22.7 kg) bag
56 bags per pallet
Colors: White

Approximate Coverage	
NOTCH TROWEL	COVERAGE
1/4" x 1/4" (6 x 6 mm)	75 - 90 ft ² (7.0 - 8.4 m ²)
1/4" x 3/8" (6 x 9 mm)	55 - 65 ft ² (5.1 - 6 m ²)



317 Mortar
Refer to Data Sheet 317.0



A smooth, creamy, sanded, non-modified thin-set mortar for interior and exterior use.

FEATURES/BENEFITS:

- For use on floors and walls over masonry, concrete, cement backer board, mortar beds, and gypsum wallboard*
 - For increased performance and flexibility, mix with 333 Flexible Additive
 - For exterior applications, mix with 3701 Mortar Admix
 - 317 Mortar mixed with 333 Flexible Additive meets ISO 13007-1 C2ES2
- *Interior only

PACKAGING:

50 lb (22.7 kg) bag
56 bags per pallet
Colors: Grey or White

Approximate Coverage	
NOTCH TROWEL	COVERAGE
1/4" x 1/4" (6 x 6 mm)	75 - 90 ft ² (7 - 8.4 m ²)
1/4" x 3/8" (6 x 9 mm)	55 - 65 ft ² (5.1 - 6 m ²)



254 PLATINUM™ Plus

Refer to Data Sheet 65329

NEW



254 PLATINUM™ Plus is the ultimate, high-performance lightweight polymer fortified, thin-set adhesive mortar ideal for interior and exterior installation of ceramic tile, porcelain tile, stone, quarry tile, pavers and brick. 254 PLATINUM Plus is offered in a 25 lb bag providing the same coverage as a 50 lb bag of traditional adhesive mortar. Featuring unsurpassed bond strength, 254 PLATINUM Plus exceeds ANSI A118.15, the highest performance standard for a cementitious adhesive mortar. With a 60-minute open time, superior transfer for maximum coverage, easy to spread creamy consistency and a lightweight formula for easier handling, 254 PLATINUM Plus is the ideal thin-set adhesive mortar for most every installation including submerged applications.

FEATURES/BENEFITS:

- Exceeds ISO 13007-C2ES1P1
- Lightweight – easy to trowel formula
- 60 minute open time
- Submerged applications
- Optimal performance for Gauged Porcelain Panels/Slabs
- Submerged applications

PACKAGING:

25 lb (11.3 kg) bag
56 bags per pallet
Colors: Grey or White

Approximate Coverage	
NOTCH TROWEL	COVERAGE
1/4" x 1/4" (6 x 6 mm)	80 – 95 ft ² (7.4 – 8.8 m ²)
1/4" x 3/8" (6 x 9 mm)	60 – 70 ft ² (5.6 – 6.5 m ²)
1/2" x 1/2" (12 x 12 mm)	35 – 40 ft ² (3.2 – 3.7 m ²)



MICROBAN

ANSI
A118.4
A118.11
A118.15E

254 PLATINUM

Refer to Data Sheet 677.0



Premium one-step, polymer-fortified, thin-set mortar that provides unsurpassed strength and versatility. Ideal for interior, exterior, thin porcelain tile and thin porcelain tile panels, and submerged applications on virtually all substrates and applications. For interior and exterior use.

FEATURES/BENEFITS:

- Exceeds ISO 13007-C2ES1P1
- Easy to trowel
- Maximum Bond strength
- Long open time
- Submerged applications

PACKAGING:

50 lb (22.7 kg) bag
56 bags per pallet
Colors: Grey or White

Approximate Coverage	
NOTCH TROWEL	COVERAGE
1/4" x 1/4" (6 x 6 mm)	80 – 95 ft ² (7.4 – 8.8 m ²)
1/4" x 3/8" (6 x 9 mm)	60 – 70 ft ² (5.6 – 6.5 m ²)
1/2" x 1/2" (12 x 12 mm)	35 – 40 ft ² (3.2 – 3.7 m ²)



MICROBAN

ANSI
A118.4
A118.11
A118.15E

#OSHA action level set forth in OSHA's Respirable Crystalline Silica (RCS) standard for construction, 29 CFR 1926.1153, as tested by an independent laboratory to be below the OSHA action level for respirable crystalline silica - see laticrete.com/silica. Antimicrobial technology protects the treated article against mold and mildew deterioration. Antimicrobial technology is not designed to replace normal cleaning practices or protect users.

254R PLATINUM™ Rapid

Refer to Data Sheet 729.0



One-step, polymer-fortified, thin-set mortar for applications requiring rapid setting. Excellent for exterior applications that require rapid setting, 254R has excellent adhesion and workability.

FEATURES/BENEFITS:

- Exceeds ISO 13007-C2FTS2
- Rapid setting, ready for grouting in 2-4 hours
- High bond strength
- Smooth, creamy and easy to install
- Interior and exterior

PACKAGING:

25 lb (11.3 kg) bag
104 bags per pallet
Colors: Grey or White

Approximate Coverage	
NOTCH TROWEL	COVERAGE
1/4" x 1/4" (6 x 6 mm)	40 – 47 ft ² (3.7 – 4.4 m ²)
1/4" x 3/8" (6 x 9 mm)	25 – 30 ft ² (2.3 – 2.8 m ²)
1/2" x 1/2" (12 x 12 mm)	20 – 23 ft ² (1.9 – 2.1 m ²)



MICROBAN

Glass Tile Adhesive Lite

Refer to Data Sheet 36628



This high performance, lightweight, non-sag, polymer fortified adhesive mortar is specifically formulated for use in glass tile applications. Glass Tile Adhesive Lite is ultra-white in color and non-sanded with a smooth easy-to-trowel consistency and extended setting time for ease of installation.

FEATURES/BENEFITS:

- Lightweight
- Extended open time
- Consistent, ultra-white color
- Optimal bond strength with minimal shrinkage
- Single component with no admix needed,
- Superior non-sag

PACKAGING:

12.5 lb (5.7 kg) bag
104 bags per pallet
Colors: White

Approximate Coverage	
NOTCH TROWEL	COVERAGE
1/4" x 1/4" (6 mm x 6 mm)	38 – 42 ft ² (3.5 – 3.9 m ²)
1/4" x 3/8" (6 mm x 9 mm)	25 – 30 ft ² (2.3 – 2.8 m ²)
1/8" x 3/16" (3 mm x 4.5 mm)	75 – 85 ft ² (7.0 – 7.9 m ²)



MICROBAN

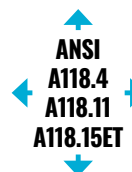

* OSHA action level set forth in OSHA's Respirable Crystalline Silica (RCS) standard for construction, 29 CFR 1926.1153, as tested by an independent laboratory to be below the OSHA action level for respirable crystalline silica - see laticrete.com/silica

253 GOLD™
Refer to Data Sheet 296.0



A polymer-fortified thin-set cementitious powder. Mix with water to install ceramic tile and stone.

FEATURES/BENEFITS:

- Exceeds ISO 13007-C2
- Bonds to most surfaces
- Interior and exterior

PACKAGING:

50 lb (22.7 kg) bag
56 bags per pallet
Colors: Grey or White

Approximate Coverage

NOTCH TROWEL	COVERAGE
1/4" x 1/4" (6 mm x 6 mm)	80 - 95 ft ² (7.4 - 8.8 m ²)
1/4" x 3/8" (6 mm x 9 mm)	60 - 70 ft ² (5.6 - 6.5 m ²)



253R GOLD Rapid
Refer to Data Sheet 296.3



An excellent solution for both interior and exterior applications that require a mortar with rapid setting characteristics.

FEATURES/BENEFITS:

- Exceeds ISO 13007-C2FEP1
- Rapid setting, ready for grouting in 2 - 4 hours
- High bond strength
- Smooth, creamy and easy to install

PACKAGING:

50 lb (22.7 kg) bag
56 bags per pallet
Colors: Grey or White

Approximate Coverage

NOTCH TROWEL	COVERAGE
1/4" x 1/4" (6 x 6 mm)	80 - 95 ft ² (7.4 - 8.8 m ²)
1/4" x 3/8" (6 x 9 mm)	60 - 70 ft ² (5.6 - 6.6 m ²)



252 SILVER™
Refer to Data Sheet 676.0



Economical solution for interior and exterior installations. Mixes with water for a strong bond.

FEATURES/BENEFITS:

- Bonds to most surfaces
- Interior and exterior

PACKAGING:

50 lb (22.7 kg) bag
56 bags per pallet
Colors: Grey or White

Approximate Coverage	
NOTCH TROWEL	COVERAGE
1/4" x 1/4" (6 x 6 mm)	80 - 95 ft ² (7.4 - 8.8 m ²)
1/4" x 3/8" (6 x 9 mm)	60 - 70 ft ² (5.6 - 6.5 m ²)



MULTIMAX™ Lite
Refer to Data Sheet 328.0



The ultimate lightweight, versatile, high performance non-sag Large and Heavy Tile mortar. A 25 lb (11.3 kg) bag provides the same coverage as a 50 lb (22.7 kg) bag of standard mortar.

FEATURES/BENEFITS:

- Exceeds ISO 13007-C2TES1P1
- Lightweight – easy to trowel formula
- Maximum non-sag, non-slump performance
- Submerged applications

PACKAGING:

25 lb (11.3 kg) bag
56 bags per pallet
Colors: grey or white

Approximate Coverage	
NOTCH TROWEL	COVERAGE
FOR WALL APPLICATION 1/4" x 3/8" (6 x 9 mm)	50 - 60 ft ² (4.6 - 5.5 m ²)
FOR LARGE HEAVY TILE 1/2" x 1/2" (12 x 12 mm)	40 - 50 ft ² (3.7 - 4.6 m ²)
FOR THIN BEDS 1/4" x 1/4" (6 x 6 mm) 1/4" x 3/8" (6 x 9 mm)	85 - 95 ft ² (7.9 - 8.8 m ²) 60 - 70 ft ² (5.5 - 6.5 m ²)

†OSHA action level set forth in OSHA's Respirable Crystalline Silica (RCS) standard for construction, 29 CFR 1926.1153, as tested by an independent laboratory to be below the OSHA action level for respirable crystalline silica - see laticrete.com/silica
Antimicrobial technology protects the treated article against mold and mildew deterioration. Antimicrobial technology is not designed to replace normal cleaning practices or protect users.

TRI-LITE™ Rapid
Refer to Data Sheet 36639



A fast setting, lightweight, high performance tri-purpose mortar designed for Large and Heavy Tile, thin-bed and wall installations. A 27.5 lb (12.5 kg) bag provides the same coverage as a 50 lb (22.7 kg) bag of standard mortar. TRI-LITE® Rapid contains no respirable crystalline silica levels that exceed the OSHA action level*.

FEATURES/BENEFITS:

- Exceeds ISO 13007-C2FTS1P1
- Lightweight – easy to trowel formula
- Excellent non-sag, non-slump performance

PACKAGING:

27.5 lb (12.5 kg) bag
Colors: white

Approximate Coverage	
NOTCH TROWEL	COVERAGE
1/4" x 1/4" (6 x 6 mm)	80 – 95 ft ² (7.4 – 8.8 m ²)
1/4" x 3/8" (6 x 9 mm)	60 – 70 ft ² (5.6 – 6.5 m ²)
1/2" x 1/2" (12 x 12 mm)	40 – 47 ft ² (3.7 – 4.4 m ²)



ANSI
A118.4
A118.11
A118.15ET

TRI-LITE
Refer to Data Sheet 320.0



A lightweight, high performance tri-purpose mortar designed for large and heavy tile, thin-bed and wall installations. Lighter to transport, easier to trowel. A 30 lb (13.6 kg) bag provides the same coverage as a 50 lb (22.7 kg) bag of standard mortar.

FEATURES/BENEFITS:

- Exceeds ISO 13007-C2TES1P1
- Lightweight
- Smooth creamy consistency
- Superior Non-Sag, Non-slump performance
- Interior and exterior applications

PACKAGING:

30 lb (13.6 kg) bag
56 bags per pallet
Colors: Grey or White

Approximate Coverage	
NOTCH TROWEL	COVERAGE
1/4" x 1/4" (6 x 6 mm)	80 – 90 ft ² (7.4 – 8.8 m ²)
1/4" x 3/8" (6 x 9 mm)	60 – 70 ft ² (5.6 – 6.5 m ²)
1/2" x 1/2" (12 x 12 mm)	40 – 47 ft ² (3.7 – 4.4 m ²)



ANSI
A118.4
A118.11
A118.15ET

4-XLT

Refer to Data Sheet 080.0



A multi-use, polymer-fortified adhesive mortar for non-sag wall installations, large and heavy tile, and thin-set applications on floors. New improved formula offers superior workability.

FEATURES/BENEFITS:

- Exceeds ISO 13007-C2TES2
- Best for build-ups to 3/4" (19 mm)

PACKAGING:

50 lb (22.7 kg) bag
56 bags per pallet
Colors: Grey or White

Approximate Coverage	
NOTCH TROWEL	COVERAGE
1/4" x 1/4" (6 x 6 mm)	80 - 95 ft ² (7.4 - 8.8 m ²)
1/4" x 3/8" (6 x 9 mm)	60 - 70 ft ² (5.6 - 6.5 m ²)
1/2" x 1/2" (12 x 12 mm)	40 - 47 ft ² (3.7 - 4.4 m ²)

ANSI
A118.4
A118.11
A118.15HT

4-XLT Rapid

Refer to Data Sheet 081.0



A fast-setting, multi-use, polymer-fortified adhesive mortar for large, heavy tile installations.

FEATURES/BENEFITS:

- For non-sag wall installations, large and heavy tile build-up, and thin-set applications on floors
- LATICRETE® Water Dispersion Technology™ disperses water in the mix for best consistency
- LATICRETE DUST LOCK™ Technology reduces mess during transportation and mixing

PACKAGING:

50 lb (22.7 kg) bag
56 bags per pallet
Colors: Grey or White

Approximate Coverage	
NOTCH TROWEL	COVERAGE
1/4" x 1/4" (6 x 6 mm)	80 - 95 ft ² (7.4 - 8.8 m ²)
1/4" x 3/8" (6 x 9 mm)	60 - 70 ft ² (5.6 - 6.5 m ²)
1/2" x 1/2" (12 x 12 mm)	40 - 47 ft ² (3.7 - 4.4 m ²)

ANSI
A118.4FHT
A118.11

* Also available in DUST LOCK™ Technology version, dramatically reducing respirable silica dust while mixing.

LHT™ Plus
Refer to Data Sheet 109.0



A polymer modified large and heavy tile mortar for installation of large format tile and stone on floors and walls. For use over most common substrates including exterior glue plywood.

FEATURES/BENEFITS:

- Smooth and creamy consistency
- Superior bond that meets the demands of challenging installations involving large and/or heavy tile
- Excellent Large Heavy Tile, 3/4" (19 mm) thick without shrinkage
- Interior and exterior installations
- For use with large format ceramic tile, porcelain tile and stone

PACKAGING:

50 lb (22.7 kg) bag
56 bags per pallet
Colors: Grey or White

Approximate Coverage	
NOTCH TROWEL	COVERAGE
1/4" x 1/4" (6 x 6 mm)	80 - 95 ft ² (7.4 - 8.8 m ²)
1/4" x 3/8" (6 x 9 mm)	60 - 70 ft ² (5.6 - 6.5 m ²)
1/2" x 1/2" (12 x 12 mm)	40 - 47 ft ² (3.7 - 4.4 m ²)



LHT™
Refer to Data Sheet 180.0



A polymer modified large and heavy tile mortar specifically formulated to provide a one-step installation for large format ceramic tile, porcelain tile, marble and stone on floors.

FEATURES/BENEFITS:

- Smooth and creamy consistency
- Superior bond that meets the demands of challenging installations involving large and/or heavy tile
- Excellent Large Heavy Tile, 3/4" (19 mm) thick without shrinkage
- Interior and exterior floor installations
- For use with large format ceramic tile, porcelain tile and stone

PACKAGING:

50 lb (22.7 kg) bag
56 bags per pallet
Colors: Grey or White

Approximate Coverage	
NOTCH TROWEL	COVERAGE
1/4" x 1/4" (6 x 6 mm)	80 - 95 ft ² (7.4 - 8.8 m ²)
1/4" x 3/8" (6 x 9 mm)	60 - 70 ft ² (5.6 - 6.5 m ²)
1/2" x 1/2" (12 x 12 mm)	40 - 47 ft ² (3.7 - 4.4 m ²)



333 Super Flexible Additive

Refer to Data Sheet 266.0



This liquid additive creates flexible thin-set mortars with superior bond strength.

FEATURES/BENEFITS:

- Mixes with all LATICRETE® pre-bagged, non-fortified, thin-set mortars for installation over concrete, brick, block, cement backer board, existing ceramic tile, cement terrazzo, exterior glue plywood*, gypsum wallboard*, vinyl tile*, linoleum*, plastic laminates*, and non-water soluble cut back adhesives*
 - Ideal for remodeling projects
 - Extra Heavy service rating per ASTM C627 (TCNA)
- *Interior only

PACKAGING:

2 gal (7.6 L) jug:
3 jugs per carton
40 cartons per pallet
5 gal (19 L) pail:
36 pails per pallet

MIXING:

2 gal (7.6 L) of 333 Flexible Additive mixes with approximately 50 lbs (22.7 kg) of LATICRETE thin-set mortars



15 Premium Mastic Adhesive

Refer to Data Sheet 286.0



A white, non-flammable, pre-mixed latex adhesive for interior installations of ceramic tile and stone, on both floors and walls.

FEATURES/BENEFITS:

- Creamy and smooth
 - For installations over cement backer board**, / gypsum wallboard, and exterior glue plywood^
 - Water-resistant
 - Exceeds ANSI A136.1 Type 1 and Type 2 requirements
- **Consult cement backer board manufacturer for specific installation recommendations ^Floors only

PACKAGING:

3.5 gal. (13.2 L) pail
48 pails per pallet

1 gallon (3.8 L) pail
4 pails per carton: 30 cartons per pallet

Approximate Coverage

NOTCH TROWEL	COVERAGE
1/8" (3 mm) V-notch	50 - 60 ft ² (4.6 - 5.6 m ²)
3/16" (5 mm) V-notch	30 ft ² (2.8 m ²)
1/4" x 1/4" (6 x 6 mm)	20 ft ² (1.9 m ²)



Made In USA™



7000 Central Park
Sandy Springs, GA, USA



To learn more about how LATICRETE contributed to this project, and many others, scan the code above.

	Multipurpose Thin-Set Mortars						Epoxy Thin-Set Adhesives	
	BEST			BETTER		GOOD	BEST	
	254 PLATINUM™ Plus	254 PLATINUM	254R PLATINUM Rapid	253 GOLD™	253R GOLD Rapid	252 SILVER™	LATAPOXY® 300 Adhesive	LATAPOXY BIOGREEN™ 300
FEATURES								
ANSI A118.15	✓	✓						
ANSI A118.11	✓	✓	✓	✓	✓	✓		
ANSI A118.4	✓	✓	✓	✓	✓	✓		
ANSI A118.3							✓	✓
ISO	C2ES1P1	C2ES1P1	C2FTS2	C2	C2FEP1		R2	R2
Lightweight	✓							
Non-Sag								
Extended Open Time	✓	✓	✓		✓			
Rapid Setting			✓		✓			
Anti-Microbial [®]	✓	✓	✓					
Chemical Resistant							✓	✓
UL GREENGUARD Certified	✓	✓		✓		✓	✓	✓
Warranty	Lifetime	Lifetime	Lifetime	10 Year	10 Year	5 Year	Lifetime	Lifetime
WHERE TO USE								
Large Heavy Tile								
Gauged Porcelain Tile	✓	✓						
Exterior	✓	✓	✓	✓	✓	✓	✓	✓
Slurry Bond Coat	✓	✓						
Submerged	✓	✓	✓				✓	✓
Glass Tile	✓	✓	✓					
Steel Substrate							✓	✓
Steam/High Humidity	✓	✓	✓				✓	✓
Exterior Façade	✓	✓						
Exterior Pedestrian	✓	✓	✓	✓			✓	✓
Industrial	✓	✓	✓				✓	✓
Vehicular Travel	✓	✓					✓	✓
Heavy Commercial	✓	✓	✓	✓	✓		✓	✓
Light Commercial	✓	✓	✓	✓	✓	✓	✓	✓
Residential	✓	✓	✓	✓	✓	✓	✓	✓

For use with Large and Heavy Tile with at least one side greater than 15 inches (381 mm), weighing 5 lbs (2.26kg) or more per square foot (square meter), or is of an ungauged thickness.							
Large and Heavy Tile Mortars							
BEST	BETTER				GOOD		
MULTIMAX™ Lite	TRI-LITE®	TRI-LITE Rapid	4-XLT	4-XLT Rapid	LHT™ Plus	LHT	
FEATURES							
ANSI A118.15	✓	✓	✓	✓			
ANSI A118.11	✓	✓	✓	✓	✓	✓	
ANSI A118.4	✓	✓	✓	✓	✓	✓	✓
ANSI A118.3							
ISO	C2TES1P1	C2TES1P1	C2FTS1P1	C2TES2	C2FTS2		
Lightweight	✓	✓	✓				
Non-Sag	✓	✓	✓	✓	✓		
Extended Open Time	✓	✓					
Rapid Setting			✓		✓		
Anti-Microbial [§]	✓						
Chemical Resistant							
UL GREENGUARD Certified	✓	✓		✓		✓	✓
Warranty	Lifetime	25 Year	25 Year	10 Year	10 Year	5 Year	5 Year
WHERE TO USE							
Large Heavy Tile	✓	✓	✓	✓	✓	✓	✓
Gauged Porcelain Tile	✓	✓		✓			
Exterior	✓	✓	✓	✓	✓	✓	✓
Slurry Bond Coat	✓						
Submerged	✓						
Glass Tile	✓						
Steel Substrate							
Steam/High Humidity	✓						
Exterior Façade	✓	✓		✓			
Exterior Pedestrian	✓	✓	✓	✓			
Industrial	✓	✓					
Vehicular Travel	✓	✓					
Heavy Commercial	✓	✓	✓	✓	✓		
Light Commercial	✓	✓	✓	✓	✓	✓	✓
Residential	✓	✓	✓	✓	✓	✓	✓

[§]Antimicrobial technology protects the treated article against mold and mildew deterioration. Antimicrobial technology is not designed to replace normal cleaning practices or protect users.



Unique Mosaics, LLC
South Salt Lake, UT, USA

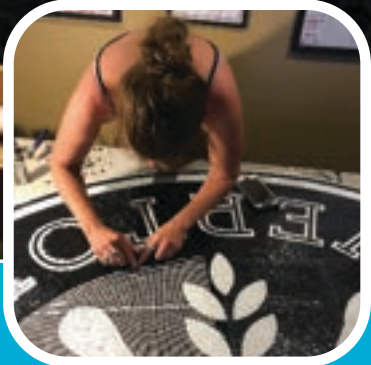
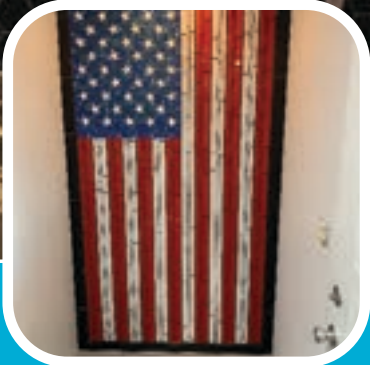

To learn more about how LATICRETE contributed to this project, and many others, scan the code above.



Tile & Stone Grouts

SPECTRALOCK® PRO Premium Translucent Grout†

Refer to Data Sheet 681.0



SPECTRALOCK® PRO Premium Translucent Grout† is a patented, extreme high performance epoxy grout that offers a unique opaque color that diffuses light and makes any design look more vibrant. It also has increased durability and stain resistance with superior ease of use and cleaning.

FEATURES/BENEFITS:

- Very Durable
- Unique Glass beads transfer light
- Stainproof* and easy to install
- Never needs sealing
- Use interior or exterior
- Great for use with Spectralock DAZZLE™

PACKAGING (all-in-one kits):

Mini Unit:

Liquid components, Part "G" glass beads (2lbs.), gloves, sponge, and cleaning packets packed in one pail 4 units per carton/45 cartons per pallet

Full Unit:

Full Unit Liquid components, Part "G" glass beads (9lbs.), gloves, sponge, and cleaning packets packed in one pail/80 pails per pallet.

Approximate Coverage

Refer to page 100 for grout coverage.



MICROBAN®

SPECTRALOCK PRO Premium Grout

Refer to Data Sheet 681.0



SPECTRALOCK PRO Premium Grout† is a patented, high performance epoxy grout that offers color uniformity, durability and stain resistance with extraordinary ease of use

FEATURES/BENEFITS:

- Stainproof*†
- Improved non-sag formula
- Exceeds ANSI A118.3
- Easy to install; never needs sealing
- Inhibits the growth of stain-causing mold and mildew with anti-microbial
- Can be used on floors and walls
- Working time of 80 minutes

COLORS:

SPECTRALOCK Grout Part C Color Additive (Sold Separately) are available in 40 colors. See Grout and Sealant Color Chart on page 98 for a list of available colors.

PACKAGING (liquids only kits):

Mini Unit:

Liquid components, gloves, sponge, and cleaning packets packed in one pail 4 units per carton/45 cartons per pallet

Full Unit:

Equals four SPECTRALOCK PRO Premium Grout Mini Units
Liquid components, gloves, sponge, and cleaning packets packed in one pail/80 pails per pallet

Commercial Unit:

Equals four SPECTRALOCK PRO Premium Grout Full Units
Liquid components, gloves, sponge, and cleaning packets packed in one carton/44 cartons per pallet. Note: SPECTRALOCK® Grout Part C filler powder required; sold separately

Approximate Coverage

Refer to page 100 for grout coverage.



MICROBAN®

SHIPPING LIMITATION: All shipments via ground only, no air shipment allowed. † United States Patent No.: 6881768 (and other Patents). *Stainproof (residential installation only) to common household cleaners, liquids, and other goods. Clean up all spills immediately. *StainProof (residential installation only) to common household cleaners, liquids and other goods. Clean all spills immediately. Antimicrobial technology protects the treated article against mold and mildew deterioration. Antimicrobial technology is not designed to replace normal cleaning practices or protect users.

SPECTRALOCK® DAZZLE™

Refer to Data Sheet 256.0



SPECTRALOCK® DAZZLE™ produces stunning design combinations when used with metallic, glass, porcelain, or any other type of tile and stone. SPECTRALOCK DAZZLE is ideal for pools, spas, backsplashes and bathroom installations; the exclusive **NEW** Blue and Green glow-in-the-dark components enhances the installation when the lights are turned off!

FEATURES/BENEFITS:

- Will not fade or deteriorate – integrally mixed
- Easy to use and clean
- For interior or exterior applications and floors

COLORS:

Gold
Silver
Copper
Black Pearl
Mother-of-Pearl
Blue Hawaii
Candied Apple
Lemonade
Limeade
Pretty in Pink
Purple Haze
Ruby Slippers
Silver
Tangerine
Blue Glow-in-the-Dark*
Green Glow-in-the-Dark*

PACKAGING:

6 pouches per carton

Recommended for use with*:

SPECTRALOCK Pro Premium Translucent
SPECTRALOCK Pro Premium
SPECTRALOCK 1 Pre-Mixed Grout
READY-TO-USE Pre-Mixed Grout

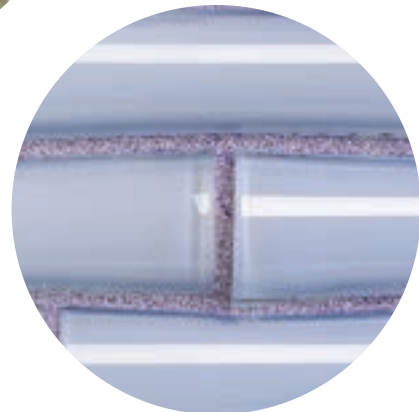
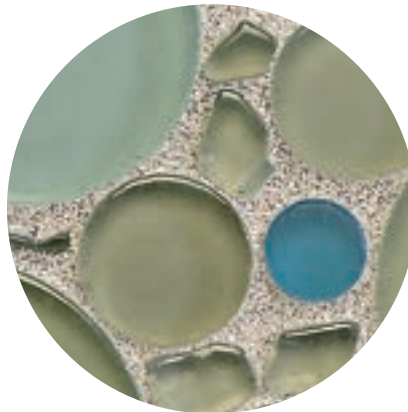

*See each product's respective data sheet for mixing instructions.

SPECTRALOCK® Grout Part C Color Additive

Refer to Data Sheet 685.0



Requires SPECTRALOCK® PRO Premium Grout AB liquids, SPECTRALOCK PRO Grout Part AB liquids, and SPECTRALOCK 2000 IG Part AB Liquids required; sold separately.

FEATURES/BENEFITS:

SPECTRALOCK PRO Premium Grout AB

COLORS:

Available in 40 colors. See Grout and Sealant Color Chart on page 98 for a list of available colors

PACKAGING:**Mini Unit:**

2.25 lb (0.9 kg) container

4 containers per carton

126 cartons per pallet

Full Unit:

9 lb (4.1 kg) container

4 containers per carton

44 cartons per pallet

Note: SPECTRALOCK 2000 IG requires 9lb (4.1 kg) container

Approximate Coverage

Refer to page 100 for grout coverage.

**SPECTRALOCK 2000 IG**

Refer to Data Sheet 030.0



SPECTRALOCK® 2000 IG is a highly chemical resistant industrial grade epoxy grout for: ceramic tile, pavers, floor brick, packing house tile, and stone.

FEATURES/BENEFITS:

- Easy to install and clean
- Unaffected by many acids, corrosives, and solvents
- Fast curing — ideal for same-day installations
- Exceeds ISO 13007-3 RG requirements

COLORS:

See Grout and Sealant Color Chart on page 98 for a list of available colors. **Requires SPECTRALOCK Grout Part C Color Additive.**

PACKAGING:

#2 Unit Pail Kit (complete unit includes Part C color additive):

Unit net weight 28.5 lb (12.9 kg)

48 pails per pallet

#2 Unit Pail (liquid only):

Unit net weight 10.5 lb (4.8 kg)

48 pails per pallet

#4 Unit Carton (liquid only):

Unit net weight 16 lb (7.3 kg)

56 cartons per pallet

SPECTRALOCK 2000 IG #2 Unit Pail with #22 Midnight Black (2000-SL0001-21) This product is recommended and designed for use in installations where the highest chemical resistance is necessary. These would include areas where there is heavy use of no-rinse cleaners, commonly known as "back-of-house" installations such as commercial kitchens. This product uses SPECTRALOCK #22 Midnight Black Part C Powder only (Included in pail).

SPECTRALOCK 2000 IG Grey #2 Unit Pail (2000- SL0001-23) and #4 Commercial Unit liquids (S-2000C- SL-03 / S-2000P-SL-03) These products are recommended to be used within applications such as: commercial "front-of-house" and other general commercial and industrial type projects. These products can be used with ALL SPECTRALOCK Grout Part C Powders (except #44 Bright White).

Approximate Coverage

Refer to page 100 for grout coverage.



SPECTRALOCK® 1*
Refer to Data Sheet 36589



Never before has a pre-mixed grout offered the superior strength and performance of an epoxy, now found in SPECTRALOCK® 1. This patented, professional grade grout offers all the benefits of SPECTRALOCK epoxy grout without the hassle of mixing. SPECTRALOCK 1 provides exceptional durability, extreme versatility, and excellent color consistency even with the most demanding applications.

FEATURES/BENEFITS:

- Locks in color and blocks out stains
- Strongest pre-mixed grout on the market
- No mixing required
- No sealing required
- Low Odor and VOC
- Patented

COLORS:

Available in 40 LATICRETE colors. See Grout and Sealant Color Chart on page 98 for a list of available colors.

PACKAGING

1 gal (3.8 L) pail, 14 lb (6.3 kg)

READY-TO-USE™ Grout
Refer to Data Sheet 027.0



READY-TO-USE™ Grout is a professional-grade, premixed grout that delivers superior color uniformity and excellent stain resistance.

FEATURES/BENEFITS:

- Easy to use and clean
- No mixing required
- No sealing required
- Maximum stain resistance

COLORS:

Available in 40 LATICRETE colors. See Grout and Sealant Color Chart on page 98 for a list of available colors.

PACKAGING

1 gal (3.8 L) pail, 14 lb (6.3 kg)

Approximate Coverage

Refer to page 101 for grout coverage.



Approximate Coverage

Refer to page 101 for grout coverage.



THE INDUSTRY'S FIRST Dispersible Dry Pigment Solution

A cementitious grout that is easy to mix, grout and clean.



Thousands of customizable color options with
PERMACOLOR® Select ANYCOLOR™!

Plus, match your grouts, sealant, and profiles & trims for a coordinated design.

With PERMACOLOR® Select ANYCOLOR™, we can now color match almost any color you can imagine including the vast Pantone®, BEHR®, Benjamin Moore® and Sherwin-Williams® palettes. Visit laticrete.com/ANYCOLOR for more details. See page 25 for more details, or [scan QR Code](#).



PERMACOLOR® Select[†] – Base

Refer to Data Sheet 281.0



PERMACOLOR Select Color Kit

Refer to Data Sheet 281.0



PERMACOLOR® Select[†] is an advanced high performance cement grout that offers the industry's first dispersible, dry pigment solution, now in a NEW formula. PERMACOLOR Select is designed for virtually all types of residential and commercial installations and offers optimum performance on the most demanding exterior or interior applications. Easy to mix, grout and clean, PERMACOLOR Select is fast setting and is suitable for joints 1/16" to 1/2" (1.5mm – 12mm) wide on floors or walls. Equipped with Microban® Anti-Microbial Protection.

FEATURES/BENEFITS:

- 20% increased strength** - Higher compressive and tensile strength, longer life, and resistance to wear and tear
- 20% enhanced stain resistance** - Less maintenance, maintaining original color with no sealing required
- Contains no respirable crystalline silica levels that exceed the OSHA action level[†] - Creating a safer work environment
- Easier to spread and clean - Faster installations with less labor and hassle
- Industries ONLY two-part system with base and dispersible dry pigment solution
- Easier to mix, store and maintain while providing a vast array of color options

COLORS:

PERMACOLOR Select Color Kit: Available in all 40 LATICRETE colors plus the top competitor colors! See Grout and Sealant Color Chart on page 98.

PERMACOLOR Select Grout Base: 20 lb (9 kg) and 10 lb (4.5 kg) plastic bags

Approximate Coverage

Refer to page 99 for grout coverage.

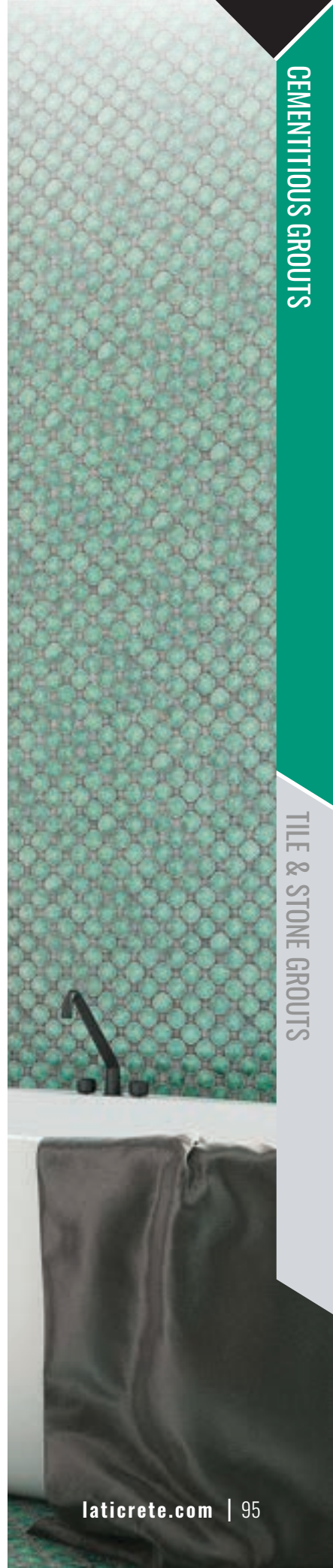

**When compared with previous PERMACOLOR® & PERMACOLOR Select Formula.*Also available in DUST LOCK™ Technology version, dramatically reducing respirable silica dust while mixing. †OSHA action level set forth in OSHA's Respirable Crystalline Silica (RCS) standard for construction, 29 CFR 1926.1153, as tested by an independent laboratory to be below the OSHA action level for respirable crystalline silica - see laticrete.com/silica. Antimicrobial technology protects the treated article against mold and mildew deterioration. Antimicrobial technology protects the treated article against mold and mildew deterioration. Antimicrobial technology is not designed to replace normal cleaning practices or protect users. †United States Invention Patent No.: 6,784,229 (and other Patents)

PERMACOLOR® Select[†] NS – Base

Refer to Data Sheet 116.0



An ultra premium, factory prepared, polymer fortified unsanded portland cement base grout designed for highly-delicate surfaces, such as high polish marble and soft glass. PERMACOLOR® Select NS Grout Base should be mixed with water and PERMACOLOR Select Color Kits – the industry's first dispersible dry pigment solution. Formulated from a blend of high strength portland cement, polymers and achieves ANSI 118.7. Provides a grout joint that is dense, hard and durable in a multitude of colors. Use on joints up to 1/2" (12 mm) between soft bisque glazed wall tile, non-vitreous clay tile, marble, stone and porcelain or glass.

FEATURES/BENEFITS:

- Mix with water and desired PERMACOLOR Select Color Kit
- Equipped with STONETECH Sealer Technology
- Contains MICROBAN®
- Excellent for wet and dry areas
- Non-dusting, non-spalling and non-yellowing
- Non-shrinking
- Easy maintenance

COLORS:

See Grout and Sealant Color Chart on page 98 for a list of available colors

PACKAGING:

8 lb (3.6 kg) box, 4 per carton, 44 cartons per pallet
 PERMACOLOR Color Kit: Available in all 40 LATICRETE colors (20 x carton) plus the top competitor colors! Each PERMACOLOR Select Color Kit contains 1 Color Pod.
 Use one Color Pod per one 8 lb (3.6 kg) bag of PERMACOLOR Select NS Grout Base.

Approximate Coverage

Refer to page 99 for grout coverage.



PERMACOLOR® Grout

Refer to Data Sheet 250.0



PERMACOLOR® Grout is a high performance, fast setting polymer fortified grout that provides a grout joint that is dense and hard. PERMACOLOR Grout is color consistent. Features built-in Microban® antimicrobial product protection to fight the growth of mold and mildew on the grout surface.

FEATURES/BENEFITS:

- 20% increased strength** - Higher compressive and tensile strength, longer life, and resistance to wear and tear
- 30% enhanced stain resistance** - Less maintenance, maintaining original color with no sealing required
- Contains no respirable crystalline silica levels that exceed the OSHA action level† - Creating a safer work environment
- Easier to spread and clean - Faster installations with less labor and hassle
- Fine aggregate - Can be used in smaller grout joint installations from 1/16" to 1/2" (1.6 – 13 mm)

COLORS:

Available in 40 LATICRETE colors. See Grout and Sealant Color Chart on page 98 for a list of available colors.

PACKAGING:

10 lb (4.5 kg) bag; 108 bags
 20 lb (9 kg) bag; 104 bags:

Approximate Coverage

Refer to page 99 for grout coverage.



**When compared with previous PERMACOLOR® & PERMACOLOR Select Formula[†]: OSHA action level set forth in OSHA's Respirable Crystalline Silica (RCS) standard for construction, 29 CFR 1926.1153, as tested by an independent laboratory to be below the OSHA action level for respirable crystalline silica - see laticrete.com/silica. Antimicrobial technology protects the treated article against mold and mildew deterioration. Antimicrobial technology is not designed to replace normal cleaning practices or protect users. †United States Invention Patent No.: 6,784,229 (and other Patents)

1500 Sanded Grout

Refer to Data Sheet 256.0



For dense, durable grout joints between 1/16" (1.5 mm) and 1/2" (12 mm). Designed for use with STONETECH® Grout Up or water.

FEATURES/BENEFITS:

- Meets ANSI A118.6 specification

COLORS:

See Grout and Sealant Color Chart on page 98 for a list of available colors.

PACKAGING:

25 lb (11.3 kg) bag:
104 bags per pallet

Approximate Coverage

Refer to page 100 for grout coverage.

**1600 Unsanded Grout**

Refer to Data Sheet 258.0



For dense, durable grout joints 1/8" (3 mm) wide or less. Designed for use with STONETECH Grout Up or water.

FEATURES/BENEFITS:

- Can be used on soft or polished stones and glass

COLORS:

See Grout and Sealant Color Chart on page 98 for a list of available colors.

PACKAGING:

8 lb (3.6 kg) box:
4 per carton
44 cartons per pallet
25 lb (11.3 kg) bag: (only in Bright White 44)
104 bags per pallet

Approximate Coverage

Refer to page 100 for grout coverage.



COLOR CHART – GROUTS, CAULKS & SEALANTS, AND PROFILES & TRIMS

COLOR CHART



Translucent

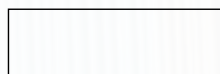

Clear



AVAILABLE IN ALL 40 COLORS:

- SPECTRALOCK® PRO Premium Grout†
SPECTRALOCK PRO Grout†
- SPECTRALOCK 1 Also available in Translucent
- READY-TO-USE™ Also available in Translucent
- PERMACOLOR® Select
PERMACOLOR Select NS
PERMACOLOR Grout*
- Premium Acrylic Caulk Sanded
- LATASIL™ Also available in Clear

AVAILABLE IN SELECTED COLORS:

- SPECTRALOCK PRO Premium Translucent Grout
- 1500 Sanded Grout 25 lbs (11.3 kg)
- 1600 Unsanded Grout 8 lbs (3.62 kg)
#44 Bright White also available in 25lb (11.3 kg) bag
- Premium Acrylic Caulk Unsanded
- Profiles & Trims**



09 Frosty



87 Stormy Grey



93 Fossil



94 Walnut



97 Iron



44 Bright White



18 Sauterne



95 Mink



96 Steamship



23 Antique White



39 Mushroom



81 Butter Cream



85 Almond

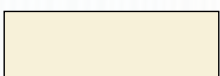

03 Silk



17 Marble Beige



40 Latte



61 Parchment

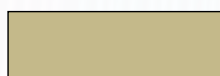

52 Toasted Almond

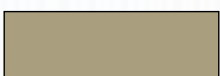

56 Desert Khaki



27 Hemp



57 Hot Cocoa



66 Chestnut Brown

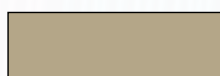

30 Sand Beige

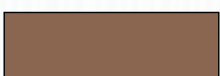

58 Terra Cotta

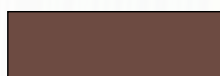

46 Quarry Red

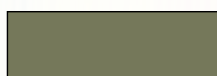

67 Autumn Green



53 Twilight Blue

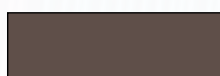

59 Espresso

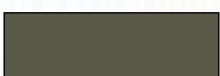

35 Mocha

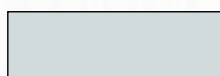

88 Silver Shadow

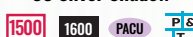

89 Smoke Grey



90 Light Pewter

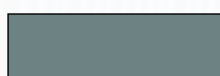
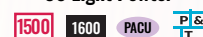

42 Platinum

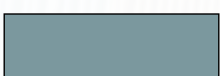

91 Slate Grey

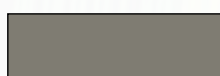

34 Sandstone

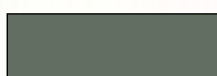

60 Dusty Grey

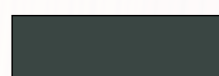

45 Raven

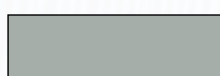

78 Sterling Silver

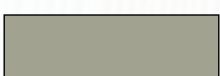

24 Natural Grey

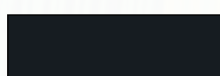

22 Midnight Black



Scan for SPECTRALOCK® 2000 IG color availability.



Scan for Color Selector providing available colors by product.

Grouts, Caulks & Sealants, and Profiles & Trims Color Guidelines – Grouts, caulks & sealants, and profiles & trims color samples are guides only. LATICRETE does not warrant color matching to this color chart or to any color guide produced. Actual shade and texture will depend on job site conditions, lighting, installation techniques and types/color of tile or stone used, and may vary from this color chart, color kit and color swatch on product packaging. Verify actual appearance and compatibility with a test area before installing. Blend grouts with different control numbers. Follow ANSI A108.10/Materials and Methods Standards Association (MMSA) Bulletin #9. No claims for color shade variations will be honored.

*Stainproof (residential installations only) to common household cleaners, liquids and other goods. Clean all spills immediately. †United States Patent No.: 6881768 (and other Patents). †United States Patent No.: 6784229 B2 (and other Patents). *Based on 2019 Clear Seas Research – Epoxy Grout Preference. **See Data Sheet Z30.99 for complete warranty information. ** Availability of profile colors and finishes will vary by material, shape, and size. Contact customer service or your LATICRETE Sales Representative for confirmation.

COLOR & COVERAGE CHART

Cementitious Grouts



PERMACOLOR® Grout[^] and PERMACOLOR Select[^]

Are maximum performance cement grouts, providing consistent color and improved strength and stain resistance. Both grouts do not require sealing. PERMACOLOR® Select requires the use of revolutionary PERMACOLOR Select Color Kits sold separately.

TILE SIZE	JOINT WIDTH				
	1/16"	1/8"	1/4"	3/8"	1/2"
Approximate ft ² (m ²) coverage per 25 lb (11.3 kg) bag.	(1.6 mm)	(3 mm)	(6.3 mm)	(9 mm)	(13 mm)
1 x 1 x 1/4" (25 x 25 x 6 mm)	103 (9.6)	53 (4.9)	29 (2.7)	21 (2.0)	17 (1.6)
4-1/2 x 4-1/2 x 5/16" (115 x 115 x 8 mm)	343 (31.9)	173 (16.1)	88 (8.2)	59 (5.5)	45 (4.2)
12 x 24 x 3/8" (305 x 610 x 9 mm)	1070 (99.4)	536 (49.8)	269 (25.0)	180 (16.7)	135 (12.5)
24 x 24 x 3/8" (610 x 610 x 9 mm)	1605 (149.1)	804 (74.7)	403 (37.4)	269 (25.0)	202 (18.8)
12 x 36 x 3/8" (305 x 915 x 9 mm)	1204 (111.9)	603 (56.0)	302 (28.1)	202 (18.8)	152 (14.1)

PERMACOLOR Select NS is an unsanded grout designed for delicate surfaces that meets ANSI 118.7. For joints up to 1/4" (6 mm).

TILE SIZE	JOINT WIDTH				
	1/16"	1/8"	3/16"	1/4"	1/2"
Approximate ft ² coverage per 8 lb (3.6 kg) Unit.	(1.6 mm)	(3 mm)	(4.5mm)	(6.3 mm)	(13 mm)
1 x 1 x 1/4" (25 x 25 x 6 mm)	34 (3.4)	17 (1.8)	12 (1.2)	9 (0.9)	5 (0.5)
2 x 2 x 1/4" (50 x 50 x 6 mm)	66 (6.8)	34 (3.4)	23 (2.3)	17 (1.6)	9 (0.8)
4-1/4 x 4-1/4 x 5/16" (108 x 108 x 8 mm)	111 (11.4)	56 (5.7)	37 (3.8)	28 (2.9)	15 (1.4)
6 x 6 x 5/16" (150 x 150 x 8 mm)	156 (14.4)	79 (7.2)	53 (4.5)	40 (3.4)	20 (1.9)
12 x 12 x 3/8" (305 x 305 x 9 mm)	261 (26.7)	131 (13.4)	87 (8.9)	66 (6.7)	33 (3.1)
24 x 24 x 3/8" (610 x 610 x 9 mm)	156 (14.4)	261 (26.7)	173 (17.8)	131 (13.4)	66 (6.1)

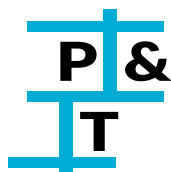

Profiles & Trims protect tile edges and visually enhance any room. Elevate your design with complementary grout-colored profiles and trims available in texture-coated aluminum, in L-Shape, Round Edge, Square Edge, and in multiple heights.



Scan for more information on [Profiles & Trims](#).

1500 1500 Sanded Grout

Approximate ft² (m²) coverage per 8 lb (3.6 kg) unit.

JOINT WIDTH

Tile Size	1/16" (1.5mm)	1/8" (3 mm)
4-1/4 x 4-1/4 x 5/16" (106 x 106 x 7.5 mm)	144 (14.7)	72 (7.4)
6 x 6 x 5/16" (150 x 150 x 7.5 mm)	202 (21.0)	102 (10.7)

1600 1600 Unsanded Grout

JOINT WIDTH

Tile Size	1/16" (1.5mm)	1/8" (3 mm)
4-1/4 x 4-1/4 x 5/16" (106 x 106 x 7.5 mm)	144 (14.7)	72 (7.4)
6 x 6 x 5/16" (150 x 150 x 7.5 mm)	202 (21.0)	102 (10.7)

Epoxy Grouts



SPECTRALOCK® PRO Premium Grout is a patented, high performance epoxy grout which offers excellent color uniformity, durability, stain protection, and beautiful, full grout joints in an easy-to-use, non-sag formula. Exceeds ANSI A118.3 requirements. Also available in Translucent.



Scan for **Color Selector** providing available colors by product

Approximate ft² (m²) coverage per gallon (3.8 L) pail.

JOINT WIDTH

TILE SIZE	1/16" (1.6 mm)	1/8" (3 mm)	1/4" (6.3 mm)	3/8" (9 mm)	1/2" (13 mm)
1 x 1 x 1/4" (25 x 25 x 6 mm)	41 (3.8)	21 (2.0)	11 (1.02)	8 (0.74)	7 (0.65)
4-1/4 x 4-1/4 x 5/16" (106 x 106 x 7.5 mm)	136 (12.6)	69 (6.4)	35 (3.25)	24 (2.2)	18 (1.7)
12 x 12 x 3/8" (305 x 305 x 9 mm)	320 (29.7)	160 (14.9)	81 (7.5)	54 (5.0)	41 (3.8)
12 x 24 x 3/8" (305 x 610 x 9 mm)	426 (39.6)	214 (19.9)	107 (9.9)	72 (6.7)	54 (5.0)

SPECTRALOCK 2000 IG is a highly chemical resistant epoxy grout. New non-sag formula is easy to install and clean. Exceeds ANSI A118.3, ANSI A118.5, and ISO 13007-3 RG requirements.

Approximate ft² (m²) coverage per #2 unit.

JOINT WIDTH

Tile Size	1/4" (6 mm)	3/8" (9 mm)	1/2" (12 mm)
4 x 8 x 1-3/16" (100 x 200 x 30 mm)	29 (2.8)	19 (1.9)	15 (1.4)
6 x 6 x 1/2" (150 x 150 x 12 mm)	77 (8.2)	52 (5.6)	39 (4.3)

Pre-Mixed Grouts



SPECTRALOCK® 1 is a patent pending, professional grade grout that offers all the benefits of SPECTRALOCK epoxy grout without the hassle of mixing. Provides exceptional durability, extreme versatility, and excellent color consistency. Also available in Translucent.



READY-TO-USE™ Grout is a professional grade, pre-mixed grout that delivers superior color uniformity and excellent stain resistance. Also available in Translucent.

TILE SIZE	JOINT WIDTH			
	1/16" (1.6 mm)	1/8" (3 mm)	1/4" (6.3 mm)	3/8" (9 mm)
1 x 1 x 1/4" (25 x 25 x 6 mm)	53 (5.4)	27 (2.8)	15 (1.5)	11 (1.1)
12 x 12 x 3/8" (305 x 305 x 10 mm)	415 (38.6)	210 (19.4)	106 (9.9)	72 (6.7)
12 x 24 x 3/8" (305 x 610 x 9 mm)	551 (57.3)	277 (28.8)	140 (14.6)	95 (9.8)
12 x 36 x 3/8" (305 x 914 x 9 mm)	619 (64.5)	311 (32.4)	158 (16.4)	106 (11)

Caulks & Sealants



LATASIL™ is a high performance, 100% silicone caulking/sealant. Approximate coverage per cartridge is 11 linear feet (3.4 linear meters) per 3/8" x 3/8" (9 mm x 9 mm) joint; 25 linear feet (7.6 linear meters) per 1/4" x 1/4" (6 mm x 6 mm) joint. Also available in Clear.



Premium Acrylic Caulk is a high performance siliconized acrylic latex sealant. Approximate coverage per cartridge is 25 linear feet (7.6 linear meters) per 1/4" x 1/4" (6 mm x 6 mm) joint. Available in sanded and unsanded.

Have a project you need help with estimating coverage?



Scan for our [Project Estimator Tool](#).

Grout Coverage Guidelines – Calculated coverage indicated is approximate, based on "nominal" tile size and is provided for purposes of estimation only. Actual coverage will vary depending on job site conditions, actual tile size and installed grout joint size. Add 10% for waste, spillage and clean-up, and another 10% – 15% when grouting unglazed quarry tile. Expanded coverage tables at laticrete.com/coverage.

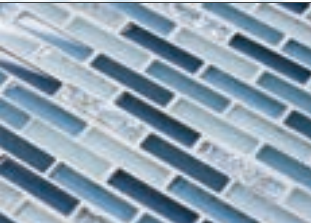
	Sanded Grouts			Unsanded Grouts	
	BEST	BETTER	GOOD	BEST	GOOD
	PERMACOLOR Select [^]	PERMACOLOR [®]	1500 Sanded Grout	PERMACOLOR Select NS	1600 Unsanded Grout
FEATURES					
ANSI A118.7	✓	✓		✓	
ANSI A118.6			✓		✓
Non-Sag					
Extended Open Time			✓		✓
Rapid Setting	✓	✓		✓	
Microban ^{®**}	✓	✓		✓	
Stainproof					
Chemical Resistant					
Water Dispersion Technology [™]	✓	✓			
UL GREENGUARD Certified	✓	✓	✓	✓	✓
Warranty	Lifetime [^]	Lifetime [^]	1 Year	Lifetime [^]	1 Year
WHERE TO USE					
Joints 1/16"–1/2"	✓	✓		✓	
Joints 1/16"–3/8"			✓		
Joints 1/8" or Less				✓	✓
Joints 1/4" or Less				✓	
Submerged	✓	✓	✓	✓	✓ [*]
Glass Tile				✓	✓
Steam/High Humidity	✓	✓		✓	✓ [*]
Exterior Façade	✓	✓	✓	✓	
Exterior Pedestrian	✓	✓	✓	✓	
Industrial					✓
Vehicular Traffic	✓	✓		✓	
Heavy Commercial	✓	✓	✓	✓	
Light Commercial	✓	✓	✓	✓	✓
Residential	✓	✓	✓	✓	✓

^{*}When mixed with STONETECH[®] GroutUp[™] Additive

	Epoxy Grouts		Pre-Mixed Grouts		Industrial Epoxy Grouts
	BEST		BETTER	BEST	BEST
	SPECTRALOCK® PRO Premium Translucent Grout †	SPECTRALOCK PRO Premium Grout	READY-TO-USE™ Grout	SPECTRALOCK 1	SPECTRALOCK 2000 IG
FEATURES					
ANSI A118.5					✓
ANSI A118.3	✓	✓		✓*	✓
Non-Sag	✓	✓	✓	✓	
Extended Open Time	✓	✓	✓	✓	✓
Rapid Setting		✓		✓	✓
Microban®**	✓	✓		✓	✓
Stainproof	✓§	✓§		✓§	✓
Chemical Resistant	✓	✓		✓	✓
Water Dispersion Technology™					
UL GREENGUARD Certified	✓	✓	✓	✓	✓
Warranty	Lifetime ^Y	Lifetime ^Y	25 Year	Lifetime ^Y	10 Year Commercial Kitchen
WHERE TO USE					
Joints 1/16"–1/2"	✓	✓	✓		✓
Joints 1/16"–3/8"				✓	
Joints 1/8" or Less					
Joints 1/4" or Less					
Submerged	✓	✓		✓	
Glass Tile	✓	✓	✓	✓	
Steam/High Humidity	✓	✓		✓	✓
Exterior Façade	✓	✓		✓	
Exterior Pedestrian	✓	✓		✓	
Industrial					✓
Vehicular Traffic	✓	✓			✓
Heavy Commercial	✓	✓		✓	✓
Light Commercial	✓	✓		✓	✓
Residential	✓	✓	✓	✓	

*United States Patent No.: 6784229 B2 (and other Patents). **See Data Sheet 025.0 for complete warranty information. *See Data Sheet 230.99 for complete warranty information. †United States Patent No.: 6881768 (and other Patents). *Meets or exceeds ANSI A118.3 specific test designation 5.6. †Stainproof (residential installations only) to common household cleaners, liquids and other goods. Clean all spills immediately. **Antimicrobial technology is not designed to protect users against disease causing microorganisms. Normal cleaning practices should be maintained.

Premium Acrylic Caulk

Refer to Data Sheet 6257.0



A siliconized acrylic latex sealant for interior use on ceramic tile and stone. Ideal for bathrooms, kitchens, and floors.

FEATURES/BENEFITS:

- Resists staining, mold, mildew
- Cleans up easily with water
- Matches all LATICRETE® grout colors
- Available in sanded and unsanded finishes

COLORS:

See Grout and Sealant Color Chart on page 94 for a list of available colors

PACKAGING:

10.5 oz (310 ml) cartridges
 6 cartridges per carton
 240 cartons per pallet

Approximate Coverage

THICKNESS	COVERAGE
1/4" x 1/4" (6 x 6 mm)	25 linear ft (7.62 m)

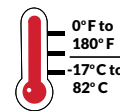
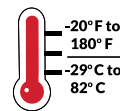

Unsanded

Sanded

LATASIL™
Refer to Data Sheet 6200.1



A 100% silicone sealant for use in coves, corners, changes in plane, and expansion joints in exterior and interior applications of tile and stone.

FEATURES/BENEFITS:

- Can be used in swimming pools and other wet areas
- Conforms to ASTM C920 and ASTM C794 adhesion properties
- Ideal for bathrooms, kitchens, floors and other areas where sealant (caulk) is needed

USES:

- Exterior and interior use
- Swimming pools and other wet area applications
- Joints for ceramic tile & stone applications
- Expansion joints in residential and commercial applications

ADVANTAGES:

- Available in ALL 40 LATICRETE grout colors and clear
- Conforms to the following properties under ASTM C-920: Type S, Grade NS, Class 25, Use NT, Use I, Use M, Use G
- Conforms to ASTM C-794 Adhesion Properties
- Equipped with anti-microbial technology
- Resistant to pool chemicals
- Easy to smooth and tool
- Excellent for masonry construction
- Excellent movement capacity – 25% extension & compression
- Can be used where ceramic tile abuts glass and window framing

COLORS:

Available in 40 colors plus Clear. See Grout and Sealant Color Chart on page 94 for a list of available colors

PACKAGING:

10.3 oz (305 ml) cartridges / 6 cartridges per carton, 240 cartons per pallet
5 Gal. (18.9 L) pails

Contact your LATICRETE Representative or Distributor for more information.

Approximate Coverage	
THICKNESS	COVERAGE
1/4" x 1/4" (6 x 6 mm)	25 linear ft (7.62 m)
3/8" x 3/8" (9 x 9 mm)	11 linear ft (3.35 m)

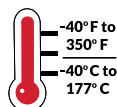

LATASIL 9118 Primer
Refer to Data Sheet 6528.1



Increases adhesion for porous stone, submerged, and permanent wet area applications.

FEATURES/BENEFITS:

- Ultimate bond for decorative wear surfaces
- Easily roller applied
- Provides a barrier between decorative wear surfaces and substrate below
- Required for applications where LATASIL™ will be used with porous stone, submerged and permanent wet areas

PACKAGING:

8 oz (240 ml) bottle; 5 bottles per carton;
50 cartons per pallet

Approximate Coverage	
THICKNESS	COVERAGE
1/4" x 1/4" (6 x 6 mm)	350 linear ft (106 m)
3/8" x 3/8" (9 x 9 mm)	175 linear ft (53 m)



Worry Less & Enjoy Life More with STONETECH®

Tile, Stone & Surface Care

Protect surfaces against stains and continuously fight the growth of bacteria, mold and mildew with STONETECH® BulletProof® Sealer enhanced with Microban Antimicrobial Technology.



STONETECH® Revitalizer® Cleaner & Protector

Refer to Data Sheet 212



A 3-in-1 formula that cleans everyday messes, reseals to reinforce stain protection, and continuously defends against the growth of bacteria on natural stone and grout surfaces..

RECOMMENDED SURFACES:

Natural stone and grout such as Marble, Granite, Limestone, Travertine, Quartzite, Slate, Sandstone, and Flagstone

FEATURES/BENEFITS:

- 3-in-1 Cleans, reseals and defends
- Built-in sealer reinforces stain protection
- Microban® antimicrobial technology continuously defends against the growth of bacteria, mold and mildew[®]
- Gentle water based formula
- Makes surfaces easier to clean
- Leaves a pleasant fragrance — in citrus or cucumber scent
- Available in ready-to-use or concentrate formulas

**STONETECH Stone & Tile Cleaner**

Refer to Data Sheet 211



The daily, pH neutral cleaner, formulated to remove tough everyday spills, dirt and grease on natural stone, tile, masonry, and grout without degrading the surface.

RECOMMENDED SURFACES:

Natural stone, masonry, tile and grout such as Marble, Granite, Limestone, Travertine, Quartzite, Slate, Sandstone, Flagstone, Concrete, Ceramic Tile, and Porcelain Tile.

FEATURES/BENEFITS:

- Daily cleaner — cleans everyday messes
- Neutral pH formula — gently cleans without degrading natural stone, tile, and grout
- Removes everyday spills, dirt and grease
- Leaves a clean fresh scent
- Better indoor air quality
- Ready-to-use or concentrate formulas

STONETECH® Quartz & Tile Cleaner

Refer to Data Sheet 166.3



The ready-to-use, daily cleaner that removes dust, dirt, spills and light stains from quartz, engineered stone and tile surfaces.

RECOMMENDED SURFACES:

For quartz, engineered stone and tile surfaces such as Quartz, Polished Marble, Polished Granite, Porcelain Tile, and Ceramic Tile.

FEATURES/BENEFITS:

- For quartz, tile, and other engineered stone
- Daily cleaner — removes everyday spill and light stains
- No rinse, water-based formula
- Leaves a clean fresh scent
- Suitable for food areas
- Low VOC — Better indoor air quality
- Great for Cambria®, Silestone®, Zodiaq®, and Caesarstone® brand surfaces



STONETECH Stainless Steel Pro Cleaner

Refer to Data Sheet 234



The professional grade cleaner that clings onto stainless steel surfaces to eliminate grease, dust, smudges, and fingerprints and leave a streak-free finish.

RECOMMENDED SURFACES:

Stainless Steel. Do not use on colored Concrete, dyed Granite, and acid-sensitive stones such as Marble, Limestone, and Travertine.

FEATURES/BENEFITS:

- Cleans, polishes, and protects
- Leaves a streak-free finish
- Removes finger prints, smudges, water spots, and oily residues
- Professional grade — no hard scrubbing or buffing needed
- Foaming-action sprayer — avoids drips and over-spray



STONETECH® KlenzAll™ Cleaner

Refer to Data Sheet 215



The heavy duty strength, alkaline cleaner made to remove the toughest dirt, grease and grime on natural stone, tile, masonry, and grout.

RECOMMENDED SURFACES:

Natural stone, tile, masonry and grout surfaces such as Marble, Granite, Limestone, Travertine, Quartzite, Slate, Sandstone, Flagstone, Concrete, Ceramic Tile, and Porcelain Tile.

FEATURES/BENEFITS:

- For natural stone, tile, masonry, and grout
- Removes tough dirt, grease, and grime
- Cleans, degreases, and prepares surface for resealing
- Safe on stone, will not etch
- Water-based, alkaline formula
- Ready-to-use or concentrate formulas



STONETECH DeepKlenz™ Cleaner†

Refer to Data Sheet 111.2



The maximum strength cleaner, formulated to easily remove deep and stubborn dirt, grease, grime, oil, and food stains from natural stone, tile, and grout.

RECOMMENDED SURFACES:

Natural stone, masonry, tile and grout, such as Marble, Granite, Limestone, Travertine, Slate, Sandstone, Concrete, Ceramic Tile, Porcelain Tile, and Stainless Steel Tile. *For other artificial stones, refer to artificial stone manufacturer.

FEATURES/BENEFITS:

- Maximum strength cleaner
- Easily removes deep and stubborn grease, oils, and food stains
- Cleans, degreases and prepares surface for resealing
- Water-based, alkaline formula
- Safe on stone
- Ready-to-use formula



STONETECH® Restore™ Acidic Cleaner

Refer to Data Sheet 216



The heavy duty, acidic cleaner removes dirt, hard water, efflorescence and rust from tile and acid resistant stone, masonry, and grout.

RECOMMENDED SURFACES:

Tile, grout and natural stone such as Ceramic Tile, Porcelain Tile, Granite, Slate, and Sandstone. Do NOT use on colored concrete, dyed Granite, and acid-sensitive stones such as Marble, Limestone, and Travertine.

FEATURES/BENEFITS:

- Heavy Duty Cleaner for tile and acid resistant stone, masonry, and grout
- Removes dirt, hard water deposits, efflorescence, and rust
- Renews the look of the surface
- Water-based, acidic formula
- No VOC — better indoor air quality



STONETECH Epoxy Grout Haze & Coating Stripper - GEL‡

Refer to Data Sheet 1664



The fast-acting, water-based gel that dissolves epoxy grout haze and tough coatings in minutes.

RECOMMENDED SURFACES:

Natural stone, tile, masonry surfaces such as granite, marble, limestone, bluestone, travertine, sandstone, slate, flagstone, quartzite, concrete, saltillo tile, quarry tile, ceramic tile and porcelain tile. Not for use on highly sensitive marbles.

FEATURES/BENEFITS:

- For natural stone, tile and masonry
- Eliminates epoxy grout haze in 10 minutes or less
- Removes epoxy grout haze and tough coatings — varnish, lacquer, sealer, wax, paint, polyurethane, and acrylic
- Fast-acting, non-runny gel — great for vertical and horizontal applications
- Water-based formula
- Low odor, low VOC and non-flammable
- No Methylene Chloride

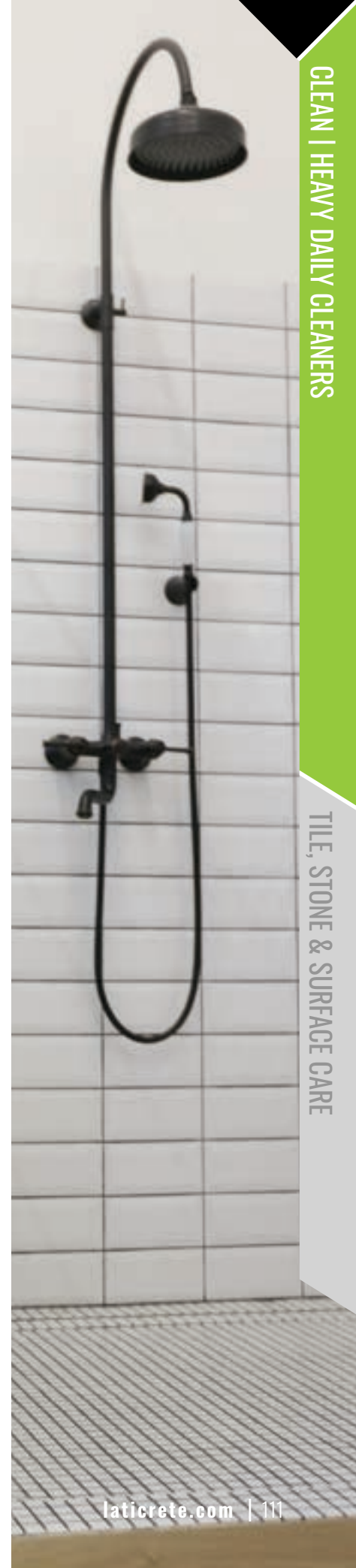

‡ NOTE: Not available for sale in Canada.

STONETECH® Oil Stain Remover

Refer to Data Sheet 214



The ready-to-use, problem solving solution to removing deep-set oil-based stains from natural stone, masonry, and grout.

RECOMMENDED SURFACES:

Natural stone, masonry and cementitious grout such as Marble, Granite, Limestone, Travertine, Quartzite, Slate, Sandstone, and Concrete.

FEATURES/BENEFITS:

- For natural stone, masonry, and grout
- Pulls out deep-set oil and grease stains
- Ready-to-use, just stir and apply
- Leaves no permanent residue

**SOLVENT
BASED**

STONETECH® Mold & Mildew Stain Remover

Refer to Data Sheet 219



The ready-to-use, specialty cleaner that removes unsightly mold and mildew stains from natural stone, tile, masonry, and grout.

RECOMMENDED SURFACES:

Natural stone, tile, masonry and grout surfaces such as Marble, Granite, Limestone, Travertine, Slate, Ceramic Tile, Porcelain Tile, Glass Tile, Brick, and unpolished poured Concrete slabs.

FEATURES/BENEFITS:

- Eliminates unsightly mold and mildew stains
- For natural stone, tile, masonry, and grout
- Won't degrade stone or grout
- Leaves a fresh, clean scent
- Foaming action sprayer — clings onto surface to avoid drips
- No VOC



STONETECH Soap Scum Remover

Refer to Data Sheet 229



The ready-to-use, powerful specialty cleaner formulated to remove soap scum, hard water stains, and dirt from natural stone, tile, and grout.

RECOMMENDED SURFACES:

Natural stone and tile surfaces such as Marble, Granite, Limestone, Travertine, Slate, Ceramic Tile, Porcelain Tile, and Glass Tile.

FEATURES/BENEFITS:

- Eliminates stubborn soap scum, hard water stains, and dirt
- For natural stone, tile, and grout
- Spray on foam, cleans, and shines
- Leaves a fresh, clean scent
- No VOC — better indoor air quality



STONETECH® BulletProof® Sealer

Refer to Data Sheet 282



The premium, water-based penetrating sealer, designed to provide maximum protection against the toughest oil and water-based stains and antimicrobial protection on the most porous natural stone, tile, masonry, and grout surfaces.

RECOMMENDED SURFACES:

For porous natural stone, tile, masonry and grout such as Marble, Granite, Basalt, Limestone, Bluestone, Travertine, Sandstone, Flagstone, Quartzite, and Saltillo Tile. Best suited for the most porous stone surfaces.

FEATURES/BENEFITS:

- Offers maximum stain protection
- Built with Microban antimicrobial technology
- Continuously inhibits the growth of bacteria, mold and mildew on the sealed surface
- Best protection for the most porous natural stone, tile, masonry and grout
- Breathable, penetrating natural look sealer preserves the original look of the surface
- Preserves the original look of the surface
- Water-based formula - better for you and the environment
- For interior and exterior use
- Professional grade



STONETECH Heavy Duty Sealer

Refer to Data Sheet 279



The heavy duty, water-based penetrating sealer that provides advanced stain and antimicrobial protection on a variety of stones, all while preserving the natural look of the stone.

RECOMMENDED SURFACES:

Natural stone and masonry surfaces such as Marble, Granite, Limestone, Slate, Bluestone, Quartzite, Travertine, Sandstone, Flagstone, and Saltillo Tile.

FEATURES/BENEFITS:

- Offers advanced stain protection
- Built with Microban antimicrobial technology
- Continuously inhibits the growth of bacteria, mold and mildew on the sealed surface
- Breathable, penetrating natural look sealer preserves the original look of the surface
- Protects natural stone, tile, masonry, and grout
- Preserves the original look of the surface
- Water-based formula - better for you and the environment
- For internal and exterior use
- Professional grade



STONETECH® Stone, Tile & Grout Sealer

Refer to Data Sheet 278



The water-based, penetrating sealer that protects against stains on natural stone, tile, masonry and grout.

RECOMMENDED SURFACES:

Natural stone such as Polished Marble, Homogeneous Granite, Polished Limestone, Slate, and Polished Travertine.

FEATURES/BENEFITS:

- Stain protection
- Protects natural stone, tile, masonry, and grout
- Preserves the original look of the surface
- Water-based formula
- For internal and exterior use



STONETECH® Impregnator Pro® Sealer

Refer to Data Sheet 238



The solvent based, penetrating sealer that provides advanced stain protection on natural stone, tile, masonry, and grout surfaces.

RECOMMENDED SURFACES:

Natural stone such as Granite, Limestone, Slate, Bluestone, Travertine, and Sandstone.

FEATURES/BENEFITS:

- Advanced stain protection
- Protects natural stone, tile, masonry, and grout
- Preserves the original look of the surface
- Solvent-based formula
- For interior and exterior use
- Professional grade

**SOLVENT
BASED**



STONETECH Quartz & Porcelain Tile Sealer

Refer to Data Sheet 166.5



The water-based sealer, designed to protect quartz, porcelain tile and medium to dense surfaces from oil and water based stains, all while preserving the natural look of the surface.

RECOMMENDED SURFACES:

Quartz, engineered stone and tile surfaces such as: Quartz, Polished Marble, Polished Granite, Porcelain Tile, and Ceramic Tile.

FEATURES/BENEFITS:

- Provides oil, water, and stains protection
- Built with Microban antimicrobial technology
- Continuously inhibits the growth of bacteria, mold and mildew on the sealed surface
- Designed for quartz, tile, and engineered stone
- Preserves the original look of the surface
- Water-based formula - better for you and the environment
- For internal and exterior use
- Suitable for food areas



STONETECH® Countertop Warranty Care Kit



Protect your customer's countertop investment with the STONETECH® Countertop warranty program. Care kit includes STONETECH BulletProof® Sealer (quart) and STONETECH Revitalizer Cleaner & Protector — citrus scent (24 oz spray) for maximum protection and daily maintenance. Covers common household food and beverage stains — etching not included.

RECOMMENDED SURFACES:

Granite, Marble, and Basalt countertops.

FEATURES/BENEFITS:

- Guarantees stain protection from common household foods and beverages
- 35-year fully transferable residential warranty
- 15-year commercial and industrial warranty
- 1-year outdoor warranty on select granite

Sealer must be applied by a certified and trained STONETECH installer. Etching is not covered. For further details on warranty program see www.stonotech.com/warranty

Brought to you by Protect Plus Surfaces™



For further warranty program details see www.stonotech.com/warranty

*Special Order – See your sales representative for details and approval.



STONETECH® Salt Water-Resistant Sealer

Refer to Data Sheet 288



The water-based, penetrating sealer formulated to protect exterior surfaces from salt degradation due to salt water and de-icing salt exposure.

RECOMMENDED SURFACES:

Best suited for porous substrates. Treatment around salt water pools: Natural Stone, Porous Tile, Concrete Pavers, Terracotta, and Grout. Protection against de-icing salts: Poured Concrete, Aggregate, Pavers, and Flagstone. Not intended for use on surfaces that have previously been exposed to salt water and/or de-icing salts.

FEATURES/BENEFITS:

- Maximum protection against salt water and de-icing salt damage
- Protects porous natural stone, masonry and grout
- Weather and UV-resistant
- Water-based formula - better for you and the environment
- For exterior use

**STONETECH Heavy Duty Exterior Sealer**

Refer to Data Sheet 212.5



The solvent based sealer designed for exterior surfaces offers advanced stain protection and weather resistance on natural stone, masonry and grout.

RECOMMENDED SURFACES:

Natural stone and masonry surfaces such as Granite, Slate, Travertine, Sandstone, Tumbled Stone, and Concrete.

FEATURES/BENEFITS:

- Advanced protection against water-based stains
- Protects natural stone, masonry, and grout
- Minimizes efflorescence and repels water
- Provides weather resistance
- Solvent-based formula
- For exterior use

**SOLVENT
BASED**





STONETECH® Heavy Duty Grout Sealer

Refer to Data Sheet 295



The water-based, penetrating sealer designed for cement-based grouts that offers advanced protection against oil and water-based stains.

RECOMMENDED SURFACES:

Cement-based grout for Natural Stone, Ceramic, and Porcelain Tile.

FEATURES/BENEFITS:

- Offers advanced protection against oil and water based stains
- Keeps grout looking newer longer
- Improves clean-ability
- Water-based formula - better for you and the environment
- For interior and exterior use



See data sheet 230.10ST for warranty information

See your LATICRETE Sales Representative for approved Canadian item numbers.

STONETECH® Grout Release

Refer to Data Sheet 213.5



The easy-to-use, pre-grout coating that offers maximum protection on natural stone and masonry to prevent grout stains and haze, making grout installation clean-up quick and easy.

RECOMMENDED SURFACES:

Natural stone, masonry and concrete such as Marble, Limestone, Travertine, Slate, Sandstone, and Tumbled Stone. Not recommended for use on ceramic and porcelain tile or dense (low absorbency) stone.

FEATURES/BENEFITS:

- Maximum protection on natural stone and masonry
- Makes grout installation clean-up easier
- Prevents grout staining and grout haze
- Water-based formula - better for you and the environment
- For interior and exterior use

**STONETECH GroutUp™ Additive**

Refer to Data Sheet 215.5



The additive that UP-grades your grout's performance with stain and antimicrobial protection.

RECOMMENDED SURFACES:

For use with cement based sanded and unsanded grouts.

FEATURES/BENEFITS:

- Stonetech Fluro-sealer Technology - advanced protection against water and oil-based stains
- Microban Antimicrobial Protection - inhibits the continuous growth of bacteria, mold & mildew
- Time Saving Solution - grout, seal and defend in one easy step
- Grout Color Consistency - does not alter grout color
- Easy to Use - simply replaces the water used in mixing
- Water-Based Formula - better for you and the environment



STONETECH® Enhancer Pro™ Sealer

Refer to Data Sheet 218.5



The color enhancing, penetrating sealer that provides a maximum deep rich color and stain protection on natural stone, masonry, and grout.

RECOMMENDED SURFACES:

Natural stone, masonry and grout such as Bluestone, Slate, Travertine, Sandstone, Limestone, Flagstone, Textured Stone, Flamed Stone, and Tumbled Stone.

FEATURES/BENEFITS:

- Deepens color of porous natural stone, masonry, and grout
- Maximum stain protection — no gloss
- For interior and exterior use
- Weather and UV resistant
- Solvent-based formula
- Professional grade

**SOLVENT
BASED**



STONETECH Enhancer & Sealer

Refer to Data Sheet 217.5



The water-based, color enhancing sealer that seals and enhances natural stone, masonry, and grout to a deep rich color.

RECOMMENDED SURFACES:

Unpolished natural stone, masonry, and grout surfaces such as Bluestone, Slate, Travertine, Limestone, Flagstone, Textured Stone, Flamed Stone, Tumbled Stone, and Concrete.

FEATURES/BENEFITS:

- Deepens color of porous natural stone, masonry, and grout
- Provides stain protection — no gloss
- For interior use
- Easy to use, water-based formula



STONETECH® High Gloss Finish & Sealer

Refer to Data Sheet 219.5



The water-based, enhancing sealer that leaves a high shine, heavy duty finish to stone, porous tile, masonry, and grout.

RECOMMENDED SURFACES:

Natural stone, porous tile, masonry, and grout surfaces such as Slate, Textured Limestone, Textured Travertine, Concrete, Saltillo Tile, Bluestone, Sandstone, and Flagstone. Not intended for use on glazed, honed, polished, or non-absorbing surfaces, wood floors and decks, showers, countertops, or near pool areas.

FEATURES/BENEFITS:

- Leaves a brilliant shine and deepens color
- Protects against water and oil based stains
- Provides a heavy duty coating
- Water-based formula — better for you and the environment
- For interior use, on textured stone, porous tile, masonry, and grout



STONETECH Semi Gloss Finish & Sealer

Refer to Data Sheet 220.5



The water-based, enhancing sealer that leaves a semi gloss, heavy duty finish on stone, porous tile, masonry, and grout.

RECOMMENDED SURFACES:

Natural stone, porous tile, masonry, and grout such as Slate, Textured Limestone, Textured Travertine, Concrete, Saltillo Tile, Bluestone Sandstone, and Flagstone. Not intended for use on glazed, honed, polished, or non-absorbing surfaces (Ceramic Tile, Porcelain Tile), wood floors and decks, showers, countertops, or near pool areas.

FEATURES/BENEFITS:

- Leaves a subtle shine and deepens color
- Protects against water and oil based stains
- Provides a heavy duty coating
- Water-based formula — better for you and the environment
- For interior use, on textured stone, porous tile, masonry, and grout





STONETECH® Stone Polish

Refer to Data Sheet 216.5



The enhancing polish, that restores the luster of polished natural stone by adding a non-greasy, streak-free protective shine.

RECOMMENDED SURFACES:

Polished natural stone such as: Marble, Granite, Limestone, Travertine, and Quartzite. NOT FOR USE ON FLOORS. MAY CREATE SLIPPING HAZARD.

FEATURES/BENEFITS:

- Shines, protects and restores
- Restores the luster of polished stone
- Leaves non-greasy, streak-free brilliant shine
- Quick and easy touch up
- Water-based formula — better for you and the environment
- Great for kitchen and bathroom countertops and vanities



STONETECH® Honing Powder

Refer to Data Sheet 225.5



The professional grade, stone restoration honing powders that eliminate mild to deep scratches and create even honed finishes. Available in extra fine to coarse grits.

RECOMMENDED SURFACES:

Natural stone such as most Marble, Limestone, Travertine, and Terrazzo.

FEATURES/BENEFITS:

- Creates an even, honed, flat finish
- Prepares stone for polishing and shining
- Available in 180, 280, 400, 600, and 800 grit levels
- Different grits eliminate mild to deep scratches
- Non-acidic for natural stone and terrazzo
- Designed for professional use

STONETECH Polishing Powder

Refer to Data Sheet 224.5



The professional grade, stone restoration powder that eliminates etch marks and light wear patterns and creates a smooth, satin finish.

RECOMMENDED SURFACES:

Natural stone such as most Marble, Limestone, Travertine, and Terrazzo.

FEATURES/BENEFITS:

- Creates a smooth, satin finish
- Eliminates etch marks and light wear patterns
- Non-acidic for natural stone
- Designed for professional use

Select the STONETECH® product that's right for your application and surface!

Use	Purpose	Product	Water Based	Surface Type					
				Granite	Marble	Limestone	Travertine	Quartzite/ Bluestone/ Sandstone	Slate
PROTECT	General-Use Sealers	STONETECH® BulletProof® Sealer ★★★	✓	✓	✓	✓	✓	✓	✓
		STONETECH Heavy Duty Sealer ★★	✓	✓	✓	✓	✓	✓	✓
		STONETECH Stone, Tile & Grout Sealer ★	✓	✓	✓	✓	—	✓	
		STONETECH Impregnator Pro® Sealer		✓	✓	✓	✓	—	✓
		STONETECH Quartz & Porcelain Tile Sealer	✓	—	—				
	Exterior	STONETECH Heavy Duty Exterior Sealer		✓		✓	✓	✓	✓
		STONETECH Salt Water Resistant Sealer	✓			✓	—	—	
	Grout	STONETECH Heavy Duty Grout Sealer ★★★	✓						
		STONETECH Grout Sealer ★★	✓						
	Installation	STONETECH Grout Release	✓		✓	✓	✓	✓	✓
STONETECH Stain Protecting Grout Additive		✓							
CLEAN	Daily Cleaners	STONETECH Revitalizer® Cleaner & Protector RTU/Concentrate	✓	✓	✓	✓	✓	✓	✓
		STONETECH Stone & Tile Cleaner RTU/Concentrate	✓	✓	✓	✓	✓	✓	✓
		STONETECH Quartz & Tile Cleaner	✓	—	—				
	Heavy Duty Cleaners/ Problem Solvers	STONETECH KlenzAll™ Cleaner RTU/Concentrate	✓	✓	✓	✓	✓	✓	✓
		STONETECH DeepKlenz™ Cleaner	✓	✓	✓	✓	✓	✓	✓
		STONETECH Restore™ Acidic Cleaner Concentrate	✓	✓				✓	✓
		STONETECH Oil Stain Remover		✓	✓	✓	✓	✓	✓
		STONETECH Epoxy Grout Haze & Coating Stripper	✓	✓				✓	✓
		STONETECH Grout Haze Remover	✓	✓	✓	✓	✓	✓	✓
		STONETECH Soap Scum Remover	✓	✓	✓	✓	✓	✓	✓
STONETECH Mold and Mildew Stain Remover	✓	✓	✓	✓	✓	✓	✓		
STONETECH Stainless Steel Pro Cleaner	✓								
ENHANCE	Enhancing Sealers & Polish	STONETECH Enhancer Pro™ Sealer		Textured	Textured	✓	✓	✓	✓
		STONETECH Enhancer & Sealer	✓	Textured	Textured	✓	✓	✓	✓
		STONETECH High Gloss Finish & Sealer	✓			Textured	Textured	✓	✓
		STONETECH Semi Gloss Finish & Sealer	✓			Textured	Textured	✓	✓
		STONETECH Stone Polish	✓	Polished	Polished	Polished	Polished	Polished	
RESTORE	Restoration	STONETECH Honing Powder/Polishing Powder			✓	✓	✓		

Note: RTU = Ready-to-Use formula

— Please call LATICRETE Technical Support for advice on this surface and product.

★★★ Best: Great for most porous surface

★★ Better: Great for medium porous surface

★ Good: Great for least porous surface

Select the STONETECH® product that's right for your application and surface!

Use	Purpose	Product	Surface Type						Stainless Steel
			Salttillo/ Terra Cotta	Clay Brick	Concrete/ Masonry	Quartz/ Engineered Stone	Ceramic/ Porcelain Tile	Grout	
PROTECT	General-Use Sealers	STONETECH® BulletProof® Sealer ★★★	✓	✓	✓			✓	
		STONETECH Heavy Duty Sealer★★	✓	✓		✓	✓	✓	
		STONETECH Stone, Tile & Grout Sealer★				✓	✓	✓	
		STONETECH Impregnator Pro® Sealer	—	—	—		✓	✓	
		STONETECH Quartz & Porcelain Tile Sealer				✓	✓		
	Exterior	STONETECH Heavy Duty Exterior Sealer		✓	✓				
		STONETECH Salt Water Resistant Sealer	✓		—				
	Grout	STONETECH Heavy Duty Grout Sealer★★★						✓	
		STONETECH Grout Sealer★★						✓	
	Installation	STONETECH Grout Release	✓	✓	✓				
STONETECH Stain Protecting Grout Additive							✓		
CLEAN	Daily Cleaners	STONETECH Revitalizer® Cleaner & Protector RTU/Concentrate	✓					✓	
		STONETECH Stone & Tile Cleaner RTU/Concentrate	✓	✓	✓	✓	✓	✓	
		STONETECH Quartz & Tile Cleaner				✓	✓	✓	
	Heavy Duty Cleaners/ Problem Solvers	STONETECH KlenzAll™ Cleaner RTU/Concentrate	✓	✓	✓		✓	✓	
		STONETECH DeepKlenz™ Cleaner	✓	✓	✓	—	✓	✓	
		STONETECH Restore™ Acidic Cleaner Concentrate	✓	✓	—		✓	✓	
		STONETECH Oil Stain Remover	✓	—	—			✓	
		STONETECH Epoxy Grout Haze & Coating Stripper	✓	✓	✓		✓	✓	
		STONETECH Grout Haze Remover	✓	✓	✓		✓	✓	
		STONETECH Soap Scum Remover	✓	✓	✓		✓	✓	
STONETECH Mold and Mildew Stain Remover	✓	✓	✓		✓	✓			
STONETECH Stainless Steel Pro Cleaner							✓		
ENHANCE	Enhancing Sealers & Polish	STONETECH Enhancer Pro™ Sealer		✓	✓				
		STONETECH Enhancer Pro™ Sealer							
		STONETECH High Gloss Finish & Sealer	✓	✓	—	Textured			
		STONETECH Semi Gloss Finish & Sealer	✓	✓	—				
		STONETECH Stone Polish							
RESTORE	Restoration	STONETECH Honing Powder/Polishing Powder							

Note: RTU = Ready-to-Use formula

— Please call LATICRETE Technical Support for advice on this surface and product.

★★★ Best: Great for most porous surface

★★ Better: Great for medium porous surface

★ Good: Great for least porous surface



WE WANT TO HEAR FROM YOU.

We love hearing from our customers! Reach out with questions, tips, or just to say hi! Follow LATICRETE on these social platforms to stay current with the latest products, tutorials, and more!

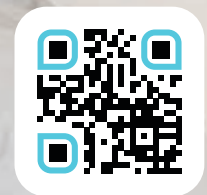

[laticrete.com](https://www.laticrete.com)



LATICRETE International, Inc. ■ One LATICRETE Park North, Bethany, CT 06524-3423 USA ■ 1.800.243.4788 ■ +1.203.393.0010 ■ www.laticrete.com

DS-1213-0524 ©2024 LATICRETE International, Inc. All trademarks shown are the intellectual properties of their respective owners.